

The Consequences of Treating Electricity as a Right

Robin Burgess, Michael Greenstone, Nicholas Ryan,
and Anant Sudarshan

High-income countries take electricity for granted: people know the lights will switch on twenty-four hours a day, 365 days a year. In developing countries, nearly a billion people are not connected to the electricity grid, and those who are receive partial and intermittent power supply. We argue that these shortfalls arise as a consequence of treating electricity as a right, rather than as a private good.

By a “right to electricity,” we refer to the social norm that all people deserve electricity regardless of payment. This entitlement has driven universal electrification programs around the world for decades and remains salient in developing countries investing in electrification today. In India, Prime Minister Narendra Modi writes, “Everyone has a right to a life of dignity. Traditionally, food and shelter have been seen as the most basic necessities. However, the Modi government has gone beyond this core basket of necessities to include even electricity” (Modi 2019). In Bolivia, the constitution itself guarantees a right to universal electricity access, and former President Evo Morales declared that electricity, among other basic services, should “be recognized in international legislation and in national standards in all

■ *Robin Burgess is Professor of Economics, London School of Economics, London, United Kingdom. Michael Greenstone is Milton Friedman Distinguished Service Professor in Economics, University of Chicago, Chicago, Illinois. Nicholas Ryan is Assistant Professor of Economics, Yale University, New Haven, Connecticut. Anant Sudarshan is South Asia Director of the Energy Policy Institute at the University of Chicago (EPIC), Chicago, Illinois. Their email addresses are r.burgess@lse.ac.uk, mgreenst@uchicago.edu, nicholas.ryan@yale.edu, and anants@uchicago.edu.*

For supplementary materials such as appendices, datasets, and author disclosure statements, see the article page at <https://doi.org/10.1257/jep.34.1.145>.

countries as a fundamental human right of the people in all corners of the planet” (Morales 2012). The UN, under Sustainable Development Goal number 7 (SDG7), has set 2030 as the date by which universal access to electricity should be achieved worldwide. Electrification has been described as a necessary step to achieving other goals, including the goals of poverty eradication (SDG1), enhancing education (SDG4), creating economic opportunity (SDG8), and empowering women (SDG5) (SEFA 2012). The push to universal electrification—irrespective of cost—is global and current.¹

How can treating electricity as a right undermine the aim of universal access to reliable electricity? We argue that there are four steps. In step 1, because electricity is seen as a right, subsidies, theft, and nonpayment are widely tolerated. Bills that do not cover costs, unpaid bills, and illegal grid connections become an accepted part of the system. In step 2, electricity utilities—also known as distribution companies—lose money with each unit of electricity sold and in total lose large sums of money. Though governments provide support, at some point, budget constraints start to bind. In step 3, distribution companies have no option but to ration supply by limiting access and restricting hours of supply. In effect, distribution companies try to sell less of their product. In step 4, power supply is no longer governed by market forces. The link between payment and supply has been severed: those evading payment receive the same quality of supply as those who pay in full. The delinking of payment and supply reinforces the view described in step 1 that electricity is a right. We describe these steps sequentially, but they can be thought of as parts of a low-quality, low-payment equilibrium. This equilibrium, we argue, is what differentiates electricity markets in developed and developing countries.

The consequences for electricity consumers, both rich and poor, are severe. There is only one electricity grid, and it becomes impossible to offer a higher quantity or quality of supply to those consumers who are willing and sometimes even desperate to pay for it. Socially beneficial transactions are therefore prevented from occurring. This interaction of the social norm that electricity is a right and the technological constraint of a common grid for all parties makes it impossible to ration service to person by person, and firm by firm, making the consequences of treating electricity as a right more severe than for other private goods. Though private alternatives to grid electricity exist, like diesel generators and solar panels, these substitutes are inferior to grid electricity in terms of price and load (Burgess et al. 2019). In fact, the only reason these substitutes are competitive at all is that the quality of the service the grid provides is so poor. The lack of close substitutes also differentiates electricity from other goods like water and fuel, which are also

¹For example, the Indian government is pushing to reach 100 percent household electrification in a context where the unelectrified are rural and poor. The USAID-led Power Africa program aims to add 60 million new electricity connections by 2030, with a focus on infrastructure construction rather than bill payment. Meanwhile, the DFID-led Energy Africa campaign is targeting universal energy access by 2030 both through grid and off-grid sources.

Figure 1

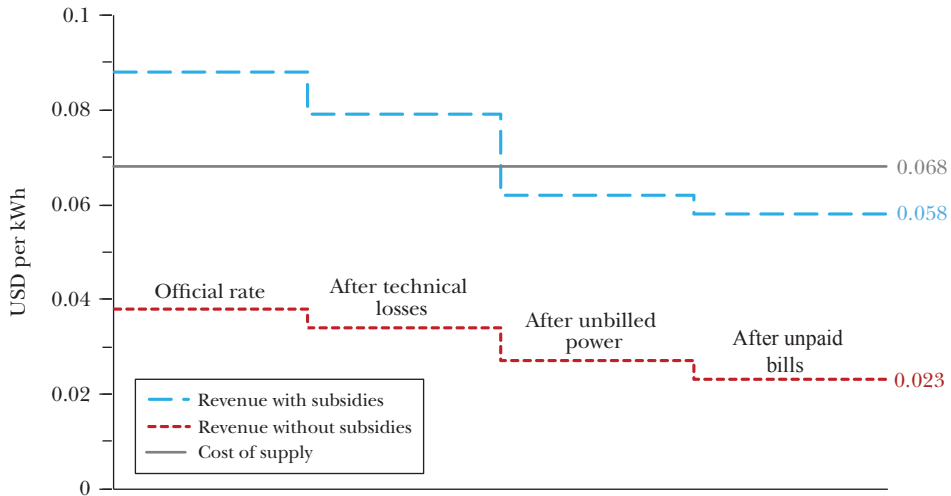
Electricity Losses in Bihar, India

Source: Statistics are from the 2019–2020 BERC Tariff Order and Tariff Schedule.

Note: Bihar-wide losses from June–September 2018 are reported. The solid line is the average power purchase cost (APPC) in Bihar, which is the average cost the utility pays to a generator to acquire one kWh of electricity. The APPC does not include costs of grid infrastructure or operation. The dotted lines show average utility revenue, with and without subsidies from the government, after cumulatively accounting for various sources of electricity loss. The official rate is for domestic consumers; industrial and other consumers may receive fewer subsidies on the margin.

subject to a universal access norm, but for which there exist a richer array of private alternatives.

When the power is switched off and villages go dark, the shortfall is often given technical terms like “load shedding,” but at root it reflects a decision by the utility to sell less. The utility cannot—without frequent government bailouts—withstand the losses that would accrue from providing the 24/7/365 electricity common in high-income countries. The nonpayment social norm implies that consumers cannot get all the electricity for which they are willing to pay. The resulting poor supply harms residential and industrial consumers across the income distribution and acts as a brake on economic development. Treating electricity as a right therefore undercuts electricity access and reliability, holding back economic growth.

To illustrate this equilibrium, Figure 1 represents the pricing of electricity in Bihar, a large Indian state that has lately undertaken wide-scale electricity reforms. The government of Bihar has placed a high priority on widespread access to electricity and expresses this priority with a substantial subsidy for the production of electricity, equal to about 80 percent of the average cost of procuring a kilowatt-hour of electricity. Consumption subsidies are uncontroversial and indeed admirable policies for a government looking to increase consumption of a good that brings social and economic benefits to millions of people. However, a widespread social

belief that electricity is a right, combined with social and political constraints, makes it difficult to charge customers for electricity and nearly impossible to disconnect consumers who do not pay.

The result is high levels of nonpayment and theft. Of the electricity produced in Bihar, about 10 percent is lost during technical reasons during transmission. Another 20 percent is taken by illegal connections and not billed for at all. Of the remaining output that is billed for, about 15 percent results in unpaid bills. Furthermore, utilities are required to set tariffs significantly below the marginal cost of supply—in 2018, average household tariffs were about 4 cents per kilowatt-hour against a cost of supply of almost 7 cents per kilowatt-hour.

The gap between the cost of supply and revenue should, in principle, be made up by government subsidies. Subsidies, however, apply only to the actual quantity of power that consumers are billed on, not the additional quantity lost to theft and nonpayment. Furthermore, the payment of subsidies can sometimes be substantially delayed, widening the gap that utilities see between revenues and costs. As a result, even with a subsidy set at about 80 percent of the procurement cost of electricity, the providers of electricity in Bihar cannot cover their operating costs.² The old yarn that “we lose money on every unit, but will make up for it on volume” describes an untenable situation for any business. Therefore, the electricity distribution companies have no choice but to ration supply.

Reforms to improve payment performance and increase revenue collection therefore must occur alongside the push towards universal access. This fundamentally involves changing the norm that electricity is a right.

In Figure 1, the dotted red line shows that the average revenue obtained per unit of power supplied in Bihar, excluding subsidies and accounting for losses from billing inefficiencies, theft, and technical losses, is 2.3 cents per kilowatt-hour. This may be compared to the average cost of 6.8 cents per kilowatt-hour at which the Bihar utility bought power from generators in 2018–2019 as shown by the solid horizontal line (Prateek 2018). The shortfall is 4.5 cents per kilowatt-hour. The dotted blue line shows the portion of this shortfall that would appear on a utility’s books, making the optimistic assumption that all subsidy reimbursements are made on-time and in-full. Although the difference here of 1.0 cents per kilowatt-hour is much smaller, this still means the utility would fall short of covering only the variable costs of electricity purchases—a far cry from attaining the cost-plus model based on which tariffs are set.

Over the remainder of this paper, we will refer to “losses” with the understanding that this is shorthand for the sum of subsidies and other losses including from theft.

²Note that this calculation, along with most of our analysis, considers variable costs. There are also subsidies for fixed costs, such as the costs of connecting a new consumer. Starting in September 2017, these fixed costs were waived entirely in Bihar for consumers below the poverty line, as part of the Indian government’s Saubhagya scheme. Consumers above the poverty line were charged only a nominal fee. As with variable subsidies, fixed subsidies are supposed to be transferred to the utility, but may not arrive in a timely fashion.

In doing so, we will abstract away from the accounting distinction³ between state-owned utilities and state governments.⁴ We do not mean this shorthand to imply that governments and utilities have the same goals.

In the conclusion to this paper, we discuss various ways in which the descent into insolvency depicted in Figure 1 can be avoided. Only in this way can countries in the developing world get to the goal of universal 24/7/365 electricity.

Figure 2 illustrates what can happen to electricity markets when electricity is viewed as a right. Every point represents an electricity “feeder,” which is a disaggregated level of the grid in Bihar that serves about 2,500 households and businesses on average.⁵ The horizontal axis reports the “revenue rate,” which we calculate as the ratio of the total revenue collected by the distribution companies at the feeder level to the revenue that would be collected if all power were paid for at prevailing tariffs.⁶ In other words, the revenue rate measures distribution company efficiency and deviates from 1.0 because of technical losses, unbilled power, and unpaid bills—the steps down in Figure 1. The left vertical axis shows the daily hours of supply for each feeder, averaged by month; there are at most twelve data points for each feeder because the sample is one year long, but because of missing data, we observe months of data for each feeder on average.

³Figure 1 illustrates both the descent into insolvency that we have discussed and an accounting consideration that can be confusing when analyzing these markets. In the equilibrium we have described, a utility has two sources of revenue. The first of these are reimbursements from the government to cover losses due to tariff subsidies or waived connection costs. The second is the revenue obtained from consumers. Because distribution companies are typically owned by the government in developing countries, subsidy reimbursements merely transfer revenue shortfalls from the books of utilities to the government, without changing the fact that these costs are ultimately paid by taxpayers.

When subsidy reimbursements are not paid in full, the burden of these shortfalls falls on the utility. As an example, the World Bank tracked electricity subsidies in Bihar over a ten-year period from 2003–2013, finding that while subsidies booked rose by 17 percent year-on-year, reimbursements grew by only 12 percent (Pargal and Banerjee 2014). Over a ten-year period, the authors estimate a shortfall of a staggering \$7.5 billion (in 2013 US dollars).

⁴In addition to this abstraction, we make certain simplifications in Figure 1 to aid exposition. First, in practice, utility losses are a weighted average of consumer-type specific losses. Thus, in a complete accounting, a similar pair of lines should be separately drawn for every consumer class. Here, we use numbers for the first block of domestic (DS-1 and DS-2) consumer tariffs, applicable to the households who consume between 0 and 50 kWh per month. The second simplification comes from our discussion of subsidy transfers. This is because in practice transfers are based not on the cost of supply, as we describe in the main text, but on consumer-type specific differences between regulatory tariffs and subsidized tariffs. This creates a network of cross-subsidies that are set such that in aggregate utilities are made whole (discounting technical losses, theft, and nonpayment). Describing this full accounting structure is beyond the scope of this paper.

⁵The figure is based on 2017–2018 data from a sample of 172 feeders that are representative of the population of feeders in eight districts of Bihar, excluding district headquarters. This paper is largely focused around the failure of developing countries to provide electricity *outside* large cities. In large urban areas, the electricity access and reliability problems are much closer to being solved. These detailed administrative data form part of a separate ongoing randomized experiment are being conducted by the authors and documented in the social science registry (AEARCTR-0000479).

⁶These tariffs may be different for different types of consumers, so the denominator of the revenue rate is not a constant multiplied by energy but rather depends on the consumer mix served.

Figure 2

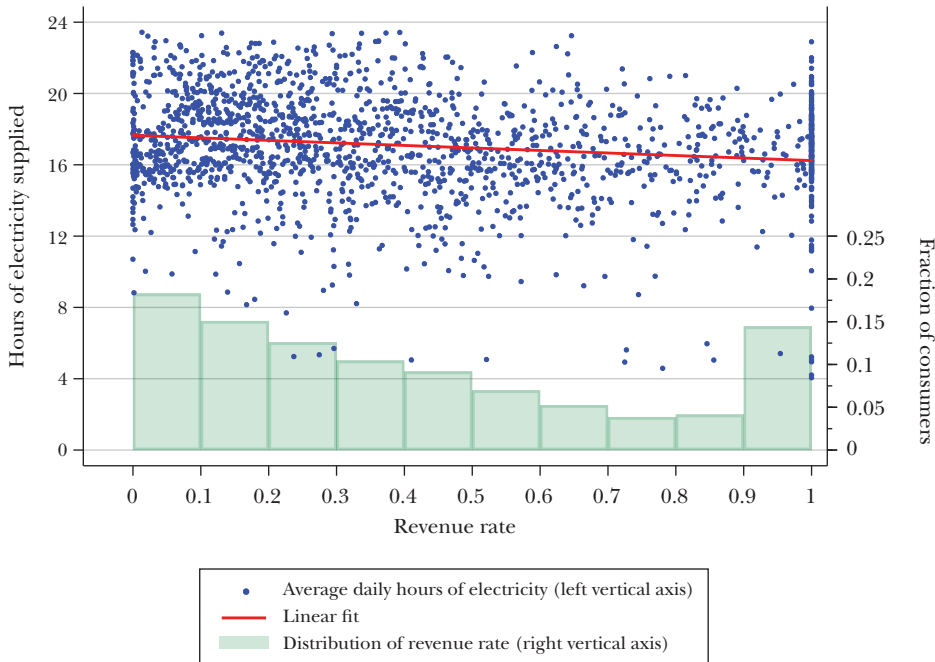
Hours of Electricity versus Fraction of Revenue Collected for Selected Feeders in Bihar

Source: Bihar Electrification Project.

Note: This figure shows the hours of electricity supplied to different areas each day (left vertical axis) against the share of the cost of electricity that each area pays (horizontal axis) for 172 feeders in north and south Bihar for the period between May 2017–April 2018. Feeders are a representative subset of the population of feeders in eight districts of Bihar, excluding district headquarters, and thus serve primarily rural areas and small towns. Each observation reflects revenue and supply in a particular month, for months in which both variables are observed in the distribution companies' administrative data at the feeder level. The revenue rate is calculated as the total payments for electricity divided by the value (at publishing post-subsidy tariff rates) of energy injected at the feeder. The revenue rate therefore ranges between zero and one for areas that pay none or all of their bills, respectively.

Three facts about the retail electricity market in rural or small-town Bihar emerge from this figure. First, the supply of electricity is heavily rationed and variable. In this sample, *no consumer* gets 24 hours of electricity every day; on average, consumers receive about 17 hours a day, and some areas get only 12 hours a day. Further, there is great temporal variation in supply within a given feeder that likely imposes costs on customers, beyond the costs associated with having less than 24 hours of service on average.

Second, revenue rates for electricity are low and variable. Our revenue rate, which measures the all-in ratio of actual revenue from customers to the value of energy injected (at published rates), is smeared out along the horizontal axis. Some areas (to the right of the figure) are paying the full share of energy value, but many

more customers pay a share of less than 0.20, on the left. The average revenue rate in this sample is only 38 percent and 75 percent of feeders pay less than two-thirds of the value of energy injection. These losses are much higher than for Bihar as a whole, in large part because this sample of feeders covers largely rural areas as well as some small urban or peri-urban portions of these districts, and thus is not representative of Bihar.⁷ It excludes large towns where the utility collects over 90 percent of what it is owed. However, this does underscore the challenges in expanding access to poor and largely rural populations, which is the primary focus of this paper.

Third, but most striking, the scatter plot shows that the relationship between how much supply people receive and how much they pay is slightly *negative*. Areas that pay for the entire cost of power tend to get a little less power than areas that pay nothing. This is evident in the solid red line of best fit that is slightly negative in slope, contrasting sharply with the market for a typical good where consumers who pay more would tend to get more.

To put these patterns in further context, consider how this graph would appear for power consumption in a high-income country. Outage rates are extremely low, so all areas would be at or extremely close to 24 hours of supply. Loss and nonpayment rates are also low, so all areas would have a revenue rate of almost one. Consequently, these scattered points would collapse to a single point in the north-east corner. In contrast, the pattern we observe in Bihar illustrates a situation where the link between payment and supply has been severed.

At the heart of this study is the recognition that the problems plaguing Bihar's electricity markets are shared, to a greater or lesser degree, by many developing countries. As we will discuss, the consequences of providing electricity regardless of payment—large subsidies, high rates of theft and nonpayment, indebted distribution companies, restricted access, and frequent blackouts for paying customers—are visible in many countries. We argue that a key part of the problem, perhaps the key part, is the same: unlike in other domains, when public provision of electricity collapses, households lack reasonably equivalent private substitutes. Electricity is a natural monopoly: average cost is decreasing for all quantities, so it is efficient to have one grid. Households do substitute, but they substitute to the equivalent of electricity autarky—off-grid diesel generators or solar panels that cost far more than grid electricity and provide smaller loads (Burgess et al. 2019). In the equilibrium we are describing, there is therefore a pent-up demand for electricity from consumers who are *able and willing to pay for it*, meaning that socially beneficial transactions simply do not take place. The rationing away of electricity from these consumers, on the intensive margin of hours of supply per day, is also mirrored by the rationing in access to electricity on the extensive margin.

⁷The statewide average revenue rate under our methodology can be read off the red line in Figure 1, that is, 2.3 divided by 3.8 or about 60 percent. As a detail, the calculation we present uses only data from residential consumers. The overall losses of the utility require a similar accounting across other consumer types and was reported in 2018–2019 at 36 percent, implying a revenue rate of 64 percent that is roughly consistent with our calculation.

The consequences of this state of affairs for development are likely severe. Electricity is an essential input for production, consumption, communication, and finance. Indeed, there are no examples of societies that have reached high living standards without consuming high levels of electricity.⁸ Confronting the global energy access and reliability problem will therefore be a key means of encouraging future growth and poverty reduction.

We lay out this argument in several stages. The following section contrasts electricity losses in low- versus high-income countries, thus providing a picture of the global extent of the problem. To understand why electricity utilities in developing countries ration their product, we next write down a graphical model. We then do a deep dive into microdata from the Indian state of Bihar to unpack in detail the mechanisms underlying the dynamics of the electricity market there. Our study site thus serves as a detailed illustration of issues we argue are widespread in developing countries. As scaffolding for this analysis, we use the four-step structure described above: 1) thanks to social norms, consumers view electricity as a right, and subsidies, theft, and nonpayment are tolerated; 2) electricity distribution becomes loss-making; 3) distribution companies ration electricity supply; and 4) supply and payment are delinked. In the conclusion, we offer some suggestions for reforms. These recommendations apply not just to Bihar but also to countries across the world seeking to obtain universal 24/7/365 electricity and the economic growth that it facilitates.

Electricity Losses around the World

A key insight from this paper is that two energy worlds coexist, one where consumers enjoy universal access to electricity 24 hours a day and another where many consumers are not on the grid and those who are connected suffer irregular supply. Panel A of Table 1 shows the differences in these worlds through statistics on electricity use for countries classified by income into four broad categories.

In some respects, the two energy worlds differ only in degree, in a way that may be taken purely as intrinsic to the differences in income levels between poor and rich countries. Electricity consumption in low-income countries is a negligible 1 percent of that in the United States; thus, world inequality in electricity is larger than income inequality. All consumers in high-income countries have electricity, whereas only 35 percent do in the low-income countries. It is plausible that some of these unconnected poor have low demand for electricity and it would lower social surplus to connect them to the grid (Lee, Miguel, and Wolfram 2019). However, we

⁸There is substantial evidence that access to reliable electricity can increase business profits, firm entry, labor productivity, and other inputs to growth (Allcott, Collard-Wexler, and O'Connell 2016; Dinkelman 2011; Kassem 2018; Fried and Lagakos 2017; Fried and Lagakos 2019; Moneke 2019). Electricity appears not only to boost output and labor supply in the short run but to raise long-run levels of productivity (Lipscomb, Mobarak, and Barham 2013). See also the companion paper in this symposium by Lee, Miguel, and Wolfram.

Table 1

Key Electricity Summary Statistics by Income Level

Quartile	Lowest	Lower middle	Upper middle	Highest
<i>A: World Electricity Overview</i>				
Population (millions)	619	2,972	2,568	1,165
GDP per capita in 2016 (% of US)	2.9	10.7	26.7	79.8
Electricity consumption per capita (% of US)	1.1	5.9	27.2	69.9
Connection to grid (%)	34.9	83.6	99.4	100.0
T&D loss (%)	22.8	16.2	9.6	6.1
Firm losses due to outages (% of output)	8.7	6.6	2.1	1.6
<i>B: Pricing in Selected Countries</i>				
Mean monthly residential consumption per electrified household (kWh)	98	103	162	574
Mean price at mean consumption level (US cents/kWh)	3.6	6.3	7.6	18.8
Mean power purchase cost (US cents/kWh)	6.4	7.2	6.6	6.2
Power purchase cost after T&D loss adjustment (US cents/kWh)	7.8	8.3	7.5	6.6
Mean price less adj. power purchase cost (US cents/kWh)	-4.2	-2.0	0.1	12.2

Source: World Bank, IEA, World Energy Council, country sources.

Note: This table shows electricity variables for four income categories of countries, using the 2018 World Bank thresholds of 2016 GNI per capita of (\$1,005; \$3,955; \$12,235). Panel A displays population-weighted averages for all countries in each income category. In Panel B, the sample consists of the ten largest countries worldwide by population as well as the three most populous in each WB income category: Ethiopia, DR Congo, and Tanzania (lowest); Bangladesh, India, Indonesia, Nigeria, Pakistan, and the Philippines (lower middle); Brazil, China, Mexico, and Russia (upper middle); and France, Japan, and the United States (highest). In Panel B, the first row is an unweighted average across selected countries. In other rows, average prices and costs are weighted by utility customers for the three largest utilities within selected countries and unweighted across selected countries. The individual country sources include government statistics websites and specific utilities' websites.

will argue that another reason for low access is due to electricity being treated as a right on the supply side of the market and that this reduces welfare by preventing socially beneficial transactions from taking place.

Certain differences between the energy worlds do not seem intrinsic to income. For example, transmission and distribution (T&D) losses are about four times higher in the low-income countries as in the high-income countries (22.8 versus 6.1 percent). Yet the technologies used for distribution are largely the same everywhere: although the levels of investment or structure of the distribution network may be different, there is no way to justify a fourfold difference in losses on technical grounds alone. The divergence must be generated at least in part by social or institutional factors that vary across countries, such as—we argue in this paper—by social norms around electricity provision that contribute to poor bill payment rates and higher losses in low-income countries.

Low-income countries also price power below cost. Panel B of Table 1 shows that in low-income countries, utilities pay a mean power purchase cost of 6.4 cents

per kWh and charge customers 3.6 cents per kWh for the same power. If we inflate power purchase costs by transmission and distribution losses, since utilities have to buy more input power to make up for the power they lose, then the input cost is 7.8 cents per kWh. Thus, the average utility in a poor country makes 46 cents per dollar of input cost—and even this calculation is optimistic, as it excludes the nonenergy variable costs of distribution and commercial losses from power billed but not paid for. Utilities in the lower-middle countries ranked by income also price power below cost (second column). But in the high-income countries, the average price paid by consumers for electricity is roughly three times higher than the mean power purchase cost for utilities (18.8 cents relative to 6.6 cents per kilowatt-hour), presumably reflecting the need to cover fixed costs and distribution company profits.

The last row of Table 1, which gives the difference between the average price the utility is paid and the average amount it must pay to generators, is therefore an upper bound on utility profit per kilowatt-hour. The difference is negative for low- and lower-middle-income countries, suggesting that *utilities in poorer countries do not cover even the raw costs of power acquired from generators*. Utilities in these income brackets are therefore unprofitable and must be supported by government subsidies and grants. Including commercial losses, like power that is billed but not paid for, would further inflate these losses. If we were to include the high fixed costs of grid infrastructure, lower-income countries would have no hope of making electricity provision profitable; even in the richest countries, utilities—as regulated monopolies—tend to barely break even after fixed network costs.⁹

We argue that these differences are not purely due to poverty, because it is conceptually possible that low-income countries would manage well-run grids, where electricity was not lost and people just used a low quantity due to low demand for electricity at low incomes. But that is not the case—people do use little electricity, but losses are high. The average price shown in Panel B is also lower in these countries, in large part due to subsidies, further increasing the gap between costs and revenues. In poor countries, therefore, utilities lose money on every unit of electricity they sell.

An implication of losing money when supplying electricity is that attempts to expand access to electricity in low-income countries will increase losses. Transmission and distribution (T&D) losses refer to the share of power generated that goes unbilled (as opposed to commercial losses, which are power billed, but not paid for). As mentioned earlier, a small amount of power (around 5 to 10 percent) is lost for unavoidable technical reasons known as “line losses.” Losses much above this level come from unregistered and registered consumers hooking onto distribution wires, unmetered power, meter tampering, or other forms of theft. In Figure 3, we plot T&D losses against percent access to electricity (the share of the population

⁹Of course, a lack of profitability in the electricity market does not itself imply that these subsidies cannot be welfare-enhancing. Rather, our point is that tackling the problems associated with electricity being viewed as a right could increase welfare by enabling socially beneficial transactions to take place.

Figure 3

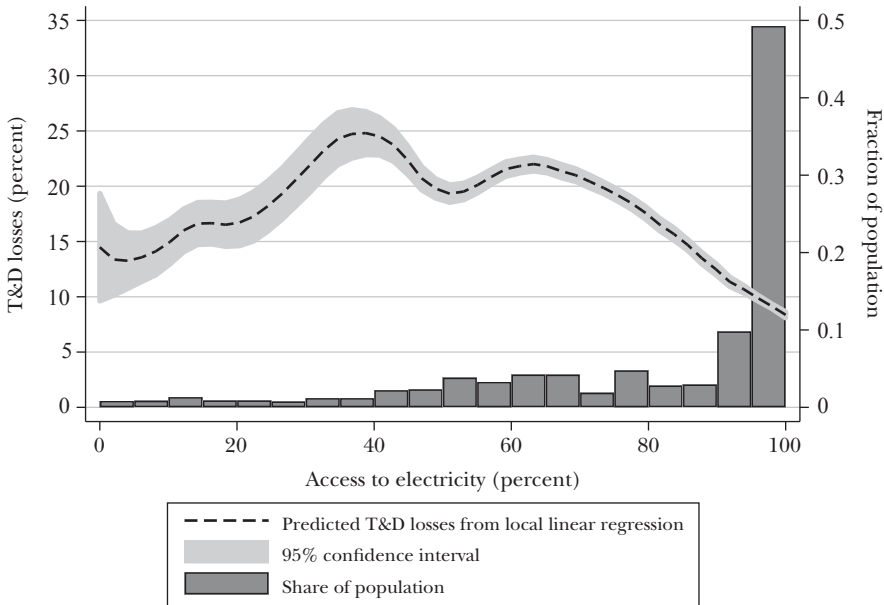
Access to Electricity and Transmission and Distribution (T&D) Losses

Source: World Bank.

Note: Each point represents one country and year for all 142 countries and years from 1990–2014 for which data are available. The local linear regression and histogram of access to electricity are both weighted by country population. T&D losses are defined as the percent of electricity generated by all power sources (in kWh) that is not billed to any consumer. Access data were originally gathered from household surveys, and T&D data are originally from national energy agencies.

with a grid connection) from 1990–2014 for all countries with available data and fit a nonparametric regression. Data from 142 countries are included with 125 of these countries having nonmissing data in all 25 years.

Figure 3 plots the result, an inverse-U shape where losses rise and then fall in access. For countries in years where access to electricity is very low, transmission and distribution (T&D) losses are high, but losses actually increase further as access expands before falling again as access approaches 100 percent. In other words, countries which are trying to expand distribution (for example, into the countryside) face the highest rates of nonpayment for electricity. At the peak of the curve, countries with about 40 percent access to electricity on average lose 25 percent of their power before it is billed to any consumer. Many states in Nigeria and India, among other places, exhibit T&D losses of 33 percent or more (Government of India Ministry of Power 2019; Nigerian Electricity Regulatory Commission 2019), which implies that the electrical utility is giving away one in three units of electricity for free. Losses then decline as payment norms are established and enforced for richer countries at higher levels of access.

We call the inverse-U relationship in Figure 3 an electricity Kuznets curve. The original Kuznets (1955) curve documented an increase and subsequent decrease in inequality as a function of income. In this version, electricity distribution companies see losses initially increase as they move up from low levels of access, but then decline as access becomes more widespread. It should be noted that our electricity Kuznets curve, like the original, relies on data from several countries and thus does not perfectly describe the path of a single country that attempts to increase access. Nevertheless, it makes clear that because electricity distribution is loss-making, governments making efforts to reach more or all of the population will for some period face higher losses.

Mechanisms: A Model to Explain Electricity Rationing

In this section, we examine the mechanisms via which viewing electricity as a right combined with its nonexcludability causes utilities to ration supply. Consider the case of two types of consumers, H (high income) and L (low income), illustrated in Figure 4. The demand curve of the H type is labeled H . The demand curve for the L type is denoted by L^{PMWTP} , which reflects their private marginal willingness to pay (which of course depends on their ability to pay, given low incomes).

The treatment of electricity as a right means that society values each unit of consumption by the poor above their own willingness-to-pay. Such a belief could arise for a variety of reasons, including because the state finds it dignified that the poor have light in their homes, due to market failures like credit constraints that limit the poor's ability to pay their full private valuation, or because there are network externalities. This belief is reflected by L^{SWTP} , which represents societal willingness-to-pay of L consumers, lying above L^{PMWTP} . Indeed, the idea that social willingness-to-pay is above private willingness-to-pay—as highlighted by statements from Indian politicians and international aid organizations in campaigns for universal electrification—is a motivation for why public provision of electricity exists in the first place (Banerjee 1997).

At marginal cost MC , the efficient quantities of consumption are A_L and A_H . However, if the state set power prices at this level, L consumers would only consume at A_L^2 , according to their own private willingness-to-pay, generating a deadweight loss relative to the social optimum determined by L^{SWTP} . This deadweight loss is denoted by the solid grey triangle in the figure and labeled as L surplus lost. Marginal cost pricing fails to deliver the social optimum here because society places a value on L consumers' consumption that is over and above their own valuation.

One option here is for the state to set a lower price, P^{listed} , below marginal cost to encourage additional consumption. At this price, the L types would increase consumption to $B_{L,list}$. The state would lose $(MC - P^{listed}) B_{L,list}$ in subsidies, and the poor consume closer to the socially efficient quantity. But notice that this subsidy

Figure 4
A Mechanism for Electricity Rationing

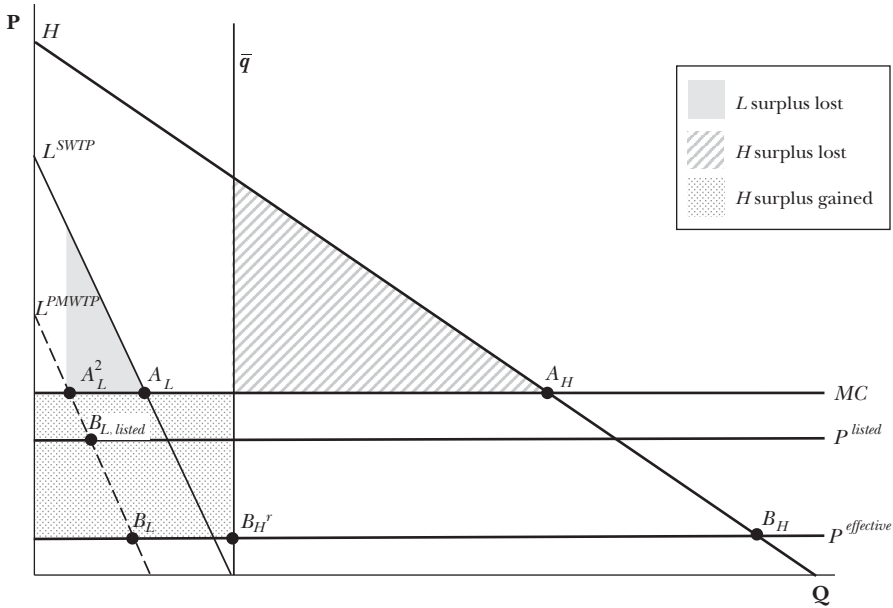

Note: This model illustrates how a perceived right to electricity, combined with the nonexcludability of electricity, leads utilities to ration supply. High-income consumers have demand H ; since society places an additional value on electricity consumption by the poor, social willingness-to-pay L^{SWTP} for low-income consumers exceeds their private demand L^{PMWTP} . Pricing electricity at marginal cost MC leads to deadweight loss for L consumers, since they consume at A_L^2 instead of the efficient quantity A_L . Pricing at a slightly lower p^{listed} , through a subsidy to L -types, increases consumption to B_L^{listed} , which is still below the efficient quantity. However, when social norms and nonexcludability result in nonpayment, the effective price falls to $p^{effective}$ and L -types can consume at B_L , close to efficient A_L . Faced with average losses of $(MC - p^{effective}) B_L$, the utility curtails supply to \bar{q} . In this equilibrium, H -types consume at B_H^r , and may face losses in surplus.

does not fully move electricity consumption of L types to the socially preferred level A_L .

However, a combination of the social norm that electricity is a right and the costs of making electricity excludable limits the ability of the state to collect revenue. The *effective* price that consumers face is therefore much lower, at $p^{Effective}$, and the poor consume B_L at this lower price. The state makes a larger loss of $(MC - p^{Effective}) B_L$, but the poor consume even closer to the efficient quantity—that is, B_L is closer to A_L than B_L^{listed} .

Moreover, if this very low price were applied to both types, the high-income H consumers would use “too much” and consume at point B_H . The loss associated with serving these consumers is larger than the loss from serving L types because the H types are richer and consume so much more. Furthermore, the state does not value the excess of their consumption over the efficient level and would make enormous losses of $(MC - p^{Effective}) B_H$ on their supply.

One solution to this problem might be to use block-rate tariffs to charge a lower price for the first increments of electricity consumers and a higher price for additional quantities. In this case, the higher income H and lower income L consumers would not face the same marginal price. The trouble is that the high costs of making electricity excludable, combined with widespread nonpayment inevitably arising from the social norm, mean that in practice, the state is not able to price discriminate between H and L types. Therefore, the effective price is indeed low for everyone (we provide some empirical evidence for this assumption later in the discussion).

However, an electricity provider under severe budgetary pressure has another instrument at its disposal: quantity rationing. One option is to limit supply to H types to the efficient level of A_H . However, at this level, the state will still make large losses and may not value the surplus of the H types at all. Furthermore, if there were many consumer types, the effective price may be very low, and the state is limited by its budget constraint. There is no reason to think utilities will be solvent with only the small degree of rationing to A_H .

Thus, in order to keep enough funds to continue supplying all the types together, the electricity provider may ration further to a point like \bar{q} . At \bar{q} , L type consumers use a quantity close to their efficient quantity and would not want to pay much higher prices for the small gain in gross surplus that pricing at cost would bring them. But H consumers have been cut back sharply to B_H^r . These consumers are using much less than the efficient level of power; the well-off farmer will not have a refrigerator, for example, or a rural metal shop will continue to use only hand tools.

Despite the fact that the high-income H types are paying low prices, their loss of surplus may be great enough that they would prefer a regime with full supply and prices raised to cover costs. The H consumer has gained the dotted area in the figure labeled “ H surplus gained,” since power is so cheap. However, the H consumer has lost the shaded triangle, “ H surplus lost,” which would have been part of consumer surplus with marginal cost pricing and no rationing. The lost surplus from rationing may well outweigh the gain from high prices; the sign of this trade-off is ambiguous. What is clear is that, due to rationing, the marginal unit of electricity for these high-income H consumers is valued far above the unit cost that they pay. Yet despite this, H consumers cannot buy more electricity.

The Consequences of Treating Electricity as a Right

This section uses empirical data to walk through the different steps that begin with treating electricity as a right, and end with crippling electricity rationing. The facts that we will document are (1) energy is viewed as a right; (2) this results in subsidies, theft, and distribution companies losing money; (3) which leads to the rationing of supply; and (4) the delinking of supply from payment. All these four factors erode payment incentives for private consumers, reinforcing the viewpoint we started with, namely that electricity is a right and not a private good.

Table 2

Customer Beliefs about Enforcement in Rural and Small-Town Bihar, India

(Percentage responses to: If you did X, how likely would it be that you would incur any penalty from the distribution company?)

	<i>Likely</i>	<i>Neutral</i>	<i>Unlikely</i>
Paying your bill late	10.1	13.6	76.3
Modifying your meter	7.9	18.2	73.9
Having an informal hooked connection	7.6	14.4	78.0
Bribing electricity officials	12.2	24.5	63.3

Source: Bihar Electrification Project endline household survey, May–August 2017.

Note: Responses are from a survey of 7,071 households in rural and small-town Bihar. Modifying a meter, having an informal hooked connection, and bribing officials all prevent a utility from observing actual electricity consumed and therefore constitute power theft.

Our evidence in this section consists mainly of microdata from Bihar, including monthly bills for over 5 million households and businesses, as well as accompanying survey data. We also incorporate some international evidence. Electricity utilities in many developing countries share remarkably similar institutional setups to those observed in Bihar. Moreover, as we have documented earlier, high levels of subsidies, theft, and nonpayment leading to high electricity losses and rationing characterize the situation in a range of developing countries. As a result, the cycle outlined below may help us to understand why restricted access and unreliable supply characterize many electricity markets.¹⁰

Step 1: Electricity Is Seen as a Right

Table 2 documents that the vast majority of customers in Bihar expect *no penalty* from paying a bill late, illegally hooking into the grid, wiring around a meter, or even bribing electricity officials to avoid payment. These attitudes are in stark contrast to how the same consumers view payment for private goods like cellphones. It is debatable whether cellphones are more important than electricity, but in Bihar we find that the poor spend three times *more* on cellphones than they do on electricity (1.7 versus 0.6 percent of total expenditure). These small expenditure shares for electricity suggest the lack of payment for electricity stems not from an inability to pay, but rather the norm of nonpayment.

A second piece of evidence comes from how poor countries set electricity prices. Figure 5 plots the published marginal price of each kilowatt-hour (kWh) of electricity, averaged across countries within a World Bank income group. The vertical lines in the figure indicate the average level of consumption for consumers

¹⁰ Clearly other factors beyond those that we examine here may contribute to this state of affairs. For example, countries such as Nigeria do not have enough power plants (installed capacity), and in Latin America power sector unions have been known to curtail electricity provision to extract rents.

Figure 5

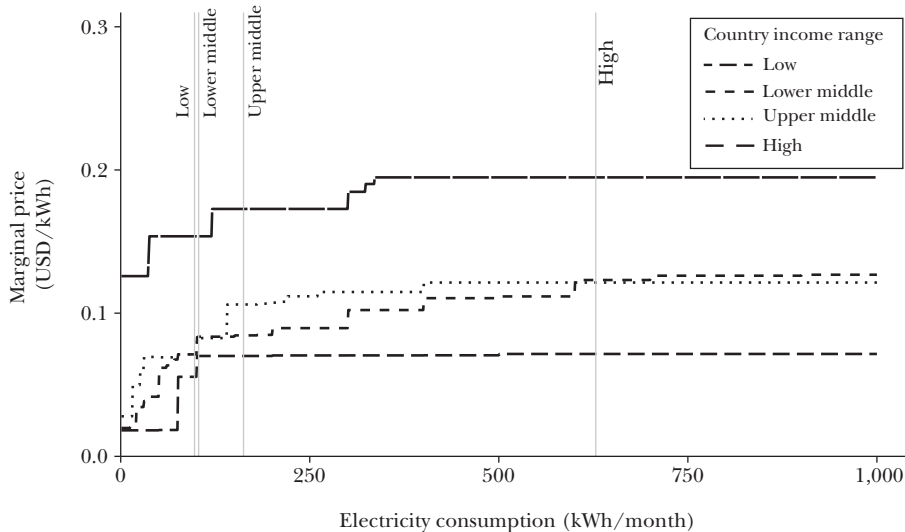
Explicit Subsidies in the Marginal Price of Power

Source: Electricity tariff (rate) schedules published by selected utilities.

Note: The graph shows the published marginal price of an additional kilowatt-hour (kWh) of power for selected countries within a 2018 World Bank income group. In general, the cheapest available domestic/household rate is used. Selected countries are in the union of the three largest countries by population in each income group and the ten largest countries worldwide. We construct each country's price schedule separately and compute unweighted average prices at each kWh level. For countries with multiple rate schedules, we use the three largest utilities by number of customers (five for India) and take a weighted average by customer count to construct the country schedule. Utilities sometimes adjust fixed charges or the marginal price on previous units when a consumption threshold is exceeded; those one-time increases in the marginal price are not included.

in each group of countries. Utilities everywhere charge less for consumers who use small amounts of power. The price of power on the first step is low and then steps up for greater consumption. Across our sample of 30 utilities in 16 countries, almost every utility charges less for the first few kilowatt-hours than for remaining units. The first steps of such tariffs are sometimes explicitly called "lifeline" tariffs, suggesting that social norms around access for the poorest can affect the utility's decision to give away electricity below cost.

While the marginal price of purchasing electricity increases with consumption in both low- and high-income countries, the difference is much greater in low-income countries (a factor of 3.9 rather than a factor of 1.5 in high-income countries). Moreover, because poor consumers use less, many more people are consuming power at the highly subsidized initial rates. Even at higher energy consumption levels, electricity rates in low-income countries tend to be much lower than in rich countries. It may be that fixed costs of distribution are also lower in poor countries, but this does not seem to be the main story, as the highest tariff steps are still below the cost of power purchase alone (as

shown earlier in Table 1). The pricing of power below cost means that electricity distribution companies are set to lose money even if every consumer paid their bills.¹¹

Beyond subsidies and technical losses, the next two steps into insolvency come from power that is not billed and nonpayment of bills (illustrated earlier in Figure 1). Unbilled power is often referred to as “theft” because a significant fraction of unbilled power may be stolen through measures such as hooking wires illegally to overhead lines. However, some power may not be billed because of billing inefficiencies on the part of the utility. We have shown that transmission and distribution losses in the electricity system are higher in poor countries, but there is not comparable data breaking down unbilled power and nonpayment across a range of countries. From our data on Bihar, however, we can look more carefully at how power is lost and who does not pay for it.

We showed earlier that the revenue rate—that is, the ratio of payment that is collected for electricity to the collections that would occur if all consumers were properly charged—is surprisingly low in rural and small-town Bihar (illustrated earlier in Figure 2). Low collection could be due to outright theft, which would show up as power that is not billed. Here, we show that a surprisingly large part of losses stem from known, formal customers not paying their bills.

Figure 6 utilizes administrative billing data from households in rural and small-town Bihar and plots the bill payment rate against monthly electricity consumed, averaged across each month in 2018 for the subset of households that receive bills. The payment rate conditional on receiving a bill (dashed line) is roughly flat across the consumption distribution, or even slightly declining, implying that bigger consumers are just as delinquent on their electricity bills as smaller ones. More than half of collection losses are due to nonpayment by consumers using over 100 kilowatt-hours per month (one minus the dotted line), though the histogram shows that they are a small subset of domestic consumers in our sample.¹²

The finding that nonpayment conditional on being a formal customer and receiving a bill is both high and constant across the distribution of consumption suggests that *de facto* low effective prices are an accepted and agreed-upon policy of the state. These customers are administratively known to the utility—clearly identifiable in their data—but are not paying and remain connected customers, while piling up debt month after month.

Step 2: Electricity Distribution Is Loss-Making

Thanks to subsidies, theft, and nonpayment, governments in poor countries lose a lot of money. The utility would be able to recover 85 percent of procurement

¹¹ Recall that our use of the term “distribution companies” is shorthand for the combination of the government and the state-owned company—if subsidies are reimbursed in full to the distribution companies, these losses simply move to the books of the state government.

¹² Data consist of individual customer bills from October 2017 to June 2018 from feeders in five districts of Bihar (out of the eight districts covered in Figure 2), all excluding district headquarters. Since payment rates in large urban centers are very high, this figure is indicative of small-town and rural consumers.

Figure 6

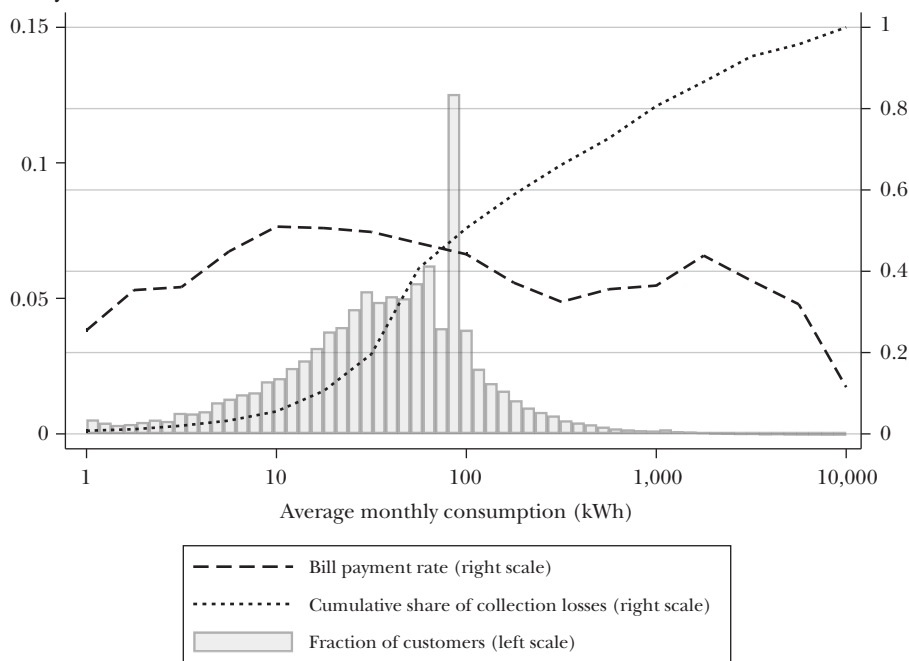
Bill Payment Rates for Selected Feeders in Bihar, India

Source: Bihar Electrification Project.

Note: The graph shows average bill payment rates by kilowatt-hour (kWh) consumption level, as well as the share of collection (bill payment) losses accounted for by consumers below that level. Only consumers who are actually billed are included. The bill payment rate equals revenue received as a share of the billed amount and therefore does not account for unbilled power (theft). Consumption brackets are 0–0.25 log₁₀ kWh, 0.25–0.50 log₁₀ kWh, etc. Customers with monthly household consumption above 100 kWh account for half of all collection losses. Data consist of electricity bills from October 2017 to June 2018 from 1.49 million unique customers. All customers are from one of five districts of North Bihar, out of the eight covered in Figure 2, all excluding district headquarters. Since payment rates in large urban centers are quite high, this figure is indicative of consumption and payment behavior of small-town and rural consumers.

costs net of subsidy transfers, but Bihar as a whole recovers about 34 percent of costs. In other words, across a population of 100 million people, payments from consumers cover less than half of the cost of power. As we discussed earlier, these losses are distributed in different ways between governments and the distribution companies they regulate, but the key point is that because revenues are less than costs on a per-unit basis, expansions of output ultimately require increases in tax revenues.

The problem with a power sector reliant on debt and subsidies is that at some point, electrical utilities run out of money. A number of countries have run up substantial power sector debt: in some cases, enough to have macroeconomic implications. In Pakistan, accumulated electricity debt is almost 4 percent of GDP (Babar 2018). India was facing stressed power debts of \$62.5 billion in mid-2018,

amounting to 2.4 percent of GDP (Engelmeier 2015). These debts, including \$30 billion of loans owed directly to distribution companies, threatened to instigate a financial crisis. Underscoring the speed at which power debt can accumulate, it should be noted that India's current distribution company debts exist in spite of a \$42 billion central government bailout in 2016 and 2017 to save states from insolvency, which followed earlier bailouts in 2011 and 2002 (PTI 2018). There appears to be a 7–10-year cycle of power sector bailouts in India.

Power sector debt in Nigeria has also been reported to scare off private investments in generation and in Ghana leads to power rationing (Akwagyirram and Carsten 2018; GhanaWeb 2018). During the Puerto Rico debt crisis in the United States, the state-run power utility owed \$9 billion in debt, in part because it gave free power for years to government-owned agencies and businesses (Walsh 2016). The implications of a loss-making electricity sector for the wider spending objectives of government are therefore nontrivial.

Step 3: Distribution Companies Ration Supply

When electricity utilities in low-income countries are losing money on each unit sold and unable to shut down due to their public mandate, the only remaining option is to sell less by purposefully restricting supply. In practice, quantity is rationed by restricting the hours of supply on the grid. This practice is given fancy names, like “load shedding,” but at its core it is a company choosing to sell less of its product even though some of its customers are willing to pay more than the cost of supply.

India is the largest country by population that faces electricity rationing. Figure 7 gives the distribution of daily hours of supply across the country in 2012. In rural areas, the median household received under 10 hours of electricity per day. Urban areas received over 19 hours. These numbers have improved, but only a small proportion of the population enjoys 24-hour electricity.

Rationing in India is not due to any absolute scarcity of capacity for generating electricity. In 2012, the year the data for Figure 7 was collected, coal plant utilization in India was under 70 percent, and in 2018, it is 55 percent. From the point of view of Bihar, which uses a small share of India's power and is connected to a national grid, an essentially perfectly elastic supply of power is available at a reasonable cost on wholesale power markets. *There is no shortage of power; rather, it is the inability to fully recoup the costs of electricity use that prevents India from providing a 24/7/365 flow of electricity to all of its citizens.* There is therefore a misallocation of power in India so that many people cannot buy the power they want. The same is true of places like Pakistan, which is now backing down from Chinese-funded coal plants, and Ethiopia, which benefits from abundant hydropower resources.

Developing countries also experience physical shortages of power and blackouts due to exogenous technical shocks, like the overheating of a transmission line. These shortages are best thought of as long-run consequences of rationing. When a high number of such shortages occur, the ultimate cause is mispricing and losses

Figure 7

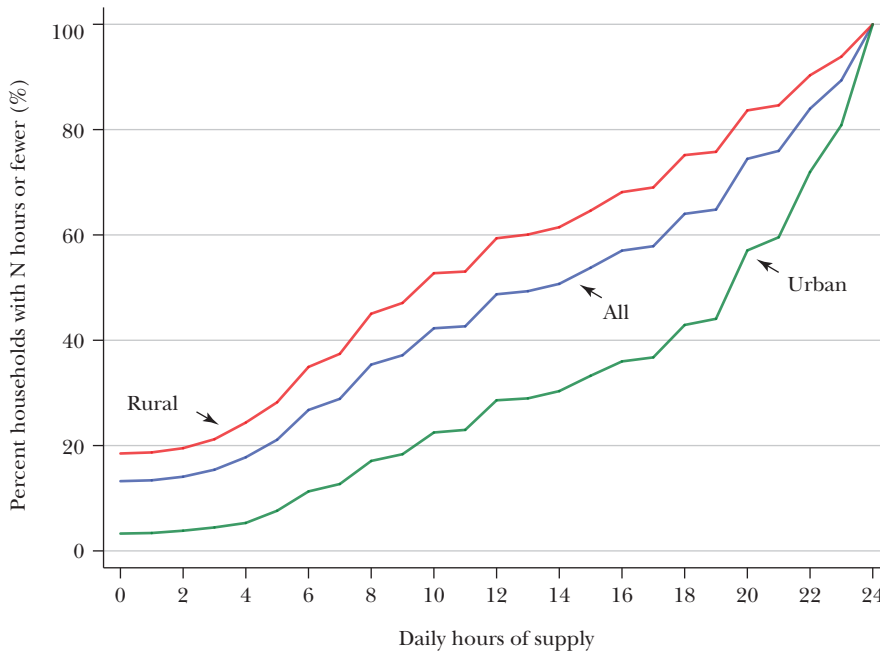
Cumulative Distribution Function of Hours of Power Supply in India

Source: IHDS 2011–2012.

Note: This figure shows the empirical cumulative distribution function of the hours of electricity supply reported by rural (red), urban (green), and all (blue) households in the India Human Development Survey, 2011–2012. Households reporting no electricity have been considered to receive zero hours of daily supply. At each point in the distribution, rural households have fewer hours of electricity than urban households. The median urban household receives over 19 hours of electricity per day, while the median rural household receives under 10 hours of electricity per day.

associated with electricity distribution. A lack of revenue flowing into the sector undercuts investment in generation and transmission. Ghana's most recent power crisis provides an example of this type (Kumi 2017). McRae (2015) shows how utilities serving a population of poor consumers may provide a low-quality supply if consumers are unwilling to pay for power, but the utility continues to serve these customers because its losses are covered by subsidies it receives from the state.

Step 4: Supply and Payment Become Delinked

The overwhelming impression from Figure 2 presented earlier is that how much a community pays bears little relationship to how many hours of electricity it receives. Supply and payment have become delinked in the market for electricity in Bihar. In principle, a utility could ration judiciously by area. At a higher level of aggregation—say, at the feeder level—electricity is perfectly excludable. For example, a utility could give 24 hours of electricity to areas with high payment rates

and less to those that do not. Alternatively, a utility could give more power to areas that value electricity more highly, perhaps because they include more businesses or public facilities like hospitals.

Even if a utility is physically able to cut off a group of delinquent customers, the right that citizens feel to electricity is a social and political concept, not a technical one. This insight helps to explain the pattern seen in Figure 2 where that rationing of electricity bears no relation to the payment rates of different areas. In continuing to keep the lights on for nonpayers, the utility reveals that it is constrained from acting like a profit-maximizing business.

A narrow interpretation is that utilities do not take this approach because of a technical limitation that they cannot ration finely enough. Recall Figure 2, where each point represents a feeder that serves a community, not individual people. Thus, even if supply were linked to feeder-level payment, customers end up being accountable for the power theft of their neighbors. A public goods problem arises here via electricity payments, where people are unwilling to pay if the result is to make it easier for their neighbors to receive electricity without paying. If the utility were able to selectively and inexpensively cut off individual consumers who do not pay, perhaps it would do so, and indeed this is common practice in the developed nations.

A broader interpretation is that under the social norm that energy is a right, the allocation of power is no longer being done on purely economic grounds, just as the pricing of power is not. If citizens engage in protests regarding a poor supply of electricity, or equivalently if government or company officials urge action to increase supply, a utility will need to take such pressures into account when making its supply decisions because ultimately it is the government that underwrites the cost of electricity provision. A growing literature documents influences of this nature on electricity supply (Mahadevan 2019; Asher and Novosad 2017; Baskaran, Min, and Uppal 2015; Shaikat 2018).

When power is supplied or rationed on criteria other than economic return and payment, consumers have little incentive to pay for electricity. They quickly learn that the way to get more power for their communities is to appeal to the local electricity grid operator, company officials, or elected representatives. The unpredictable supply makes many consumers feel that they are being treated unfairly and additionally weakens incentives to pay. Consequently, the four-part cycle we have described will repeat itself.

Conclusion and Possible Reforms

When a social norm develops that electricity is a right, firms and people in developing countries are cut off from a vast array of consumption and production activities relative to a world with 24/7/365 electricity access. Firms from many different sectors that require a continuous supply of electricity cannot enter these markets and existing firms have to constrain their growth or rely on costly diesel

generators (Allcott et al. 2016). Households, rationed off the grid altogether, substitute to costly alternatives like diesel and off-grid solar power, or forego electricity entirely when given these inferior options (Burgess et al. 2019). They are consequently unable to make use of a whole range of life-enhancing appliances. We do not observe the latent demand that firms and people have for continuous, reliable electricity because electricity with these characteristics is not offered.

What is the way out? We offer a taxonomy of reform in four areas: explicit subsidy reform, changing social norms, better technology, and privatization. Many of these policies are complements. They share a longer-run goal of changing the way people think about electricity—that is, their aim is to break the social norm that electricity is a right. They are particularly important because countries or regions of countries that have universal electrification as their ultimate goal will need to employ them so that each additional electricity customer is profitable rather than loss-making.

First, countries could reduce explicit subsidies for electricity, both in size and in scope, while continuing to support the poor. Subsidies on electricity are often enjoyed by consumers across the income distribution, which both makes them regressive and furthers the notion that power is an entitlement. For example, government might instead provide direct benefits to the poorest members of society. If needed for the transition, a well-defined category of poor consumers may receive a “tagged” subsidy payment equal to the subsidies they would have received under current subsidized electricity prices. Indonesia is an example of a country that has moved away from energy subsidies towards direct transfers, though its policy has wavered lately (Burke and Kurniawati 2018).

Second, reforms might seek to reduce theft of electricity and nonpayment of bills. In Bihar, we engaged in a large-scale experiment involving 28 million consumers to enact such a scheme. Under this initiative, the hours of electricity provided by the utility to a feeder were explicitly linked to bill collection rates via a transparent and heavily publicized schedule. This policy targets utility supply. However, losses remain high because we can only target payment by groups of 13,000 people but not individual customers. A similar initiative is underway nationally in Pakistan, allowing utilities there to cut off areas that are the most egregious offenders. In these efforts, it is critical to communicate the benefits of paying for electricity. In Bihar, bill inserts, posters, text messages, and public announcements were used to relay how communities paying more would receive longer hours of electricity. Similarly, in Sao Paulo, utilities held meetings with *de facto* leaders of slums before introducing billing; in Delhi, one utility hired 800 women from informal settlements to act as community liaisons (Lawaetz 2018).

A related set of reforms provides incentives to distribution company employees who collect electricity payments. In theory, these high-performance incentives both elicit greater collection effort and break the collusion whereby consumers offer electricity bribes to the bill collectors, rather than paying for electricity (Khan, Khwaja, and Olken 2016). We are involved in evaluating an experimentally assigned scheme where utility employees in Bihar move from flat payments to one where they also retain a proportion of revenue from bills collected.

Bill collection may be aided by social trust—when the collectors are your neighbors, it is harder to ignore them. Rural electrification in the United States was achieved largely through rural electrification cooperatives, which were groups of farmers that maintained the grid and collected bills (Lewis and Severnini forthcoming; Kitchens and Fishback 2015). The history of electrification in China and South Korea also involved local engagement with the electricity sector. Initial electrification was mainly funded by communities rather than the national government, and in some cases farmers were hired part time as bill collectors (Aklin et al. 2018; Niez 2010). Rural communities were eventually connected to the national grid in the 2000s, but reported electricity losses remained low, perhaps because of early local buy-in (Bhattacharyya and Ohiare 2012).

A third type of reform relies on technology to make electricity excludable, therefore making it possible to explicitly link payments and supply at the individual level. Smart meters can require payments in advance or allow the utility to cut off household electricity supply remotely. Smart meters have been shown to reduce power consumption in some contexts (Jack and Smith 2015). That said, there remains a need for more evidence from high-theft environments because even the best meter does nothing if a consumer connects themselves directly to the line on the street or can wire around a meter. Better monitoring can also be undercut by bureaucratic collusion, as highlighted in the healthcare literature (Banerjee, Duflo, and Glennerster 2008).

Fourth, why not aim to privatize distribution in the hope that this leads to a market for electricity? A comparison often mentioned here is that the cellphone market in many developing countries is run through private markets. However, the political economy of electricity distribution makes the leap to privatization in many developing country contexts difficult. As long as electricity is perceived as a right by all parties, effective privatization is not feasible (Reddy and Sumithra 1997). The case of Odisha, a poor state neighboring Bihar, is illustrative. The state distribution companies were among the earliest in India to be restructured and privatized, but have continued to suffer some of the highest loss rates in the country for two decades (as high as 34 percent as of 2018) and require continued subsidization (PowerLine 2018).

Where privatization has sufficient public support, it might improve efficiency. For example, Delhi privatized electricity distribution in 2002 and has seen incredibly rapid reductions in losses and improvements of supply—partly through the social engagement and technical reforms recommended above. Even so, power prices have remained a political hot button. In 2015, the Delhi government reintroduced a significant 50 percent power subsidy for all consumers who use less than 400 kilowatt-hours per month (Tongia 2017). With this threshold, over 80 percent of households in the city received the subsidy. In September 2019, the subsidy was made even more generous, with consumption below 200 kilowatt-hours made completely free. Beyond the large direct costs of this policy, it remains to be seen whether such a policy might reintroduce the norm of electricity being a right and affect payment behavior more broadly, including among the middle and upper

classes to whom the subsidy sometimes applies. This possibility underscores the fragility of a high payment equilibria when electricity is still seen as a right.

We conclude with the reminder that 24/7/365 electricity remains out of reach for the majority of people in developing countries. Macro solutions, like privatization of the electricity industry or construction of ever more wires and plants, come into and out of favor, but we believe they are targeting the symptoms, not the cause. High losses and poor quality supply will persist, despite ambitious reforms, so long as electricity is treated as a right.

References

- Aklin, Michaël, Patrick Bayer, S.P. Harish, and Johannes Urpelainen.** 2018. *Escaping the Energy Poverty Trap: When and How Governments Power the Lives of the Poor*. Cambridge: MIT Press.
- Akwagyiram, Alexis, and Paul Carsten.** 2018. "Exclusive: Nigerian Energy Sector's Crippling Debts Delay Next Power Plant." London: Reuters.
- Allcott, Hunt, Allan Collard-Wexler, and Stephen D. O'Connell.** 2016. "How Do Electricity Shortages Affect Industry? Evidence from India." *American Economic Review* 106 (3): 587–624.
- Asher, Sam, and Paul Novosad.** 2017. "Politics and Local Economic Growth: Evidence from India." *American Economic Journal: Applied Economics* 9 (1): 229–73.
- Banerjee, Abhijit V.** 1997. "A Theory of Misgovernance." *Quarterly Journal of Economics* 112 (4): 1289–1332.
- Banerjee, Abhijit V., Esther Duflo, and Rachel Glennerster.** 2008. "Putting a Band-Aid on a Corpse: Incentives for Nurses in the Indian Public Health Care System." *Journal of the European Economic Association* 6 (2–3): 487–500.
- Baskaran, Thushyanthan, Brian Min, and Yogesh Uppal.** 2015. "Election Cycles and Electricity Provision: Evidence from a Quasi-experiment with Indian Special Elections." *Journal of Public Economics* 126: 64–73.
- Bhattacharyya, Subhes C., and Sanuse Ohiare.** 2012. "The Chinese Electricity Access Model for Rural Electrification: Approach, Experience and Lessons for Others." *Energy Policy* 49 (3): 676–87.
- Burgess, Robin, Michael Greenstone, Nicholas Ryan, and Anant Sudarshan.** 2019. "Demand for Electricity in a Poor Economy." <http://www.lse.ac.uk/economics/Assets/Documents/personal-pages/robin-burgess/demand-for-electricity-in-a-poor-economy.pdf>.
- Burke, Paul J., and Sandra Kurniawati.** 2018. "Electricity Subsidy Reform in Indonesia: Demand-Side Effects on Electricity Use." *Energy Policy* 116: 410–21.
- Davis, Lucas W., and Lutz Kilian.** 2011. "The Allocative Cost of Price Ceilings in the U.S. Residential Market for Natural Gas." *Journal of Political Economy* 119 (2): 212–41.
- Dinkelman, Taryn.** 2011. "The Effects of Rural Electrification on Employment: New Evidence from South Africa." *American Economic Review* 101 (7): 3078–3108.
- Duflo, Esther, Rema Hanna, and Stephen P. Ryan.** 2012. "Incentives Work: Getting Teachers to Come to School." *American Economic Review* 102 (4): 1241–78.
- Engelmeier, Tobias.** 2015. "Will India's Power Sector Run Out of Debt?" <https://www.linkedin.com/pulse/indias-power-sector-run-out-debt-tobias-engelmeier/>.
- Fried, Stephanie, and David Lagakos.** 2017. "Rural Electrification, Migration and Structural Transformation: Evidence from Ethiopia." International Growth Centre Working Paper E-32301-ETH-1.
- Fried, Stephanie, and David Lagakos.** 2019. "Cottage Industry to Factories? The Effects of Electrification on the Macroeconomy." Paper presented at the Econometric Society Winter Meetings, Atlanta, GA.
- GhanaWeb.** 2018. Power Rationing Imminent as GRIDCo Reels under Huge Debt. <https://www.ghanaweb.com/GhanaHomePage/NewsArchive/Power-rationing-imminent-as-GRIDCo-reels-under-huge-debt-683468#>.

- Government of India Ministry of Power.** 2019. *UDAY National Dashboard*. <https://www.uday.gov.in/home.php> (accessed November 1, 2019).
- Jack, B. Kelsey, and Grant Smith.** 2015. "Pay as You Go: Prepaid Metering and Electricity Expenditures in South Africa." *American Economic Review* 105 (5): 237–41.
- Kassem, Dana.** 2018. "Does Electrification Cause Industrial Development? Grid Expansion and Firm Turnover in Indonesia." Universität Bonn Discussion Paper CRC TR 224.
- Khan, Adnan Q., Asim I. Khwaja, and Benjamin A. Olken.** 2016. "Tax Farming Redux: Experimental Evidence on Performance Pay for Tax Collectors." *Quarterly Journal of Economics* 131 (1): 219–71.
- Kitchens, Carl, and Price Fishback.** 2015. "Flip the Switch: The Impact of the Rural Electrification Administration 1935–1940." *Journal of Economic History* 75 (4): 1161–95.
- Kumi, Ebenezer Nyarko.** 2017. *The Electricity Situation in Ghana: Challenges and Opportunities*. Washington, DC: Center for Global Development.
- Kuznets, Simon.** 1955. "Economic Growth and Income Inequality." *American Economic Review* 45 (1): 1–28.
- Lawaetz, Simone.** 2018. *Advancing Power Sectors' Self-Reliance through Electricity System Loss Reduction*. Washington, DC: Energy at US Agency for International Development.
- Lee, Kenneth, Edward Miguel, and Catherine Wolfram.** 2019. "Experimental Evidence on the Economics of Rural Electrification." https://www.dropbox.com/s/ougxs9jtchzkj3m/REPP-Paper_2019-02-04_Final.pdf?dl=0.
- Lewis, Ethan, and Edson Severnini.** Forthcoming. "Short- and Long-Run Impacts of Rural Electrification: Evidence from the Historical Rollout of the U.S. Power Grid." *Journal of Development Economics*.
- Lipscomb, Molly, A. Mushfiq Mobarak, and Tania Barham.** 2013. "Development Effects of Electrification: Evidence from the Topographic Placement of Hydropower Plants in Brazil." *American Economic Journal: Applied Economics* 5 (2): 200–31.
- Mahadevan, Meera.** 2019. *The Price of Power: Costs of Political Corruption in Indian Electricity*. https://conference.nber.org/conf_papers/f130302.pdf.
- McRae, Shaun.** 2015. "Infrastructure Quality and the Subsidy Trap." *American Economic Review* 105 (1): 35–66.
- Moneke, Niclas.** 2019. "Can Big Push Infrastructure Unlock Development? Evidence from Ethiopia." https://niclasmoneke.com/wp-content/uploads/Moneke-JMP-Big_Push_Infrastructure.pdf.
- Morales, Evo.** 2012. *Manifiesto de la Isla del Sol: Ten Commandments against Capitalism, for Life and Humanity*. La Paz: printed by the author.
- Modi, Narendra.** 2019. *When Development Ensures Dignity*. <https://www.narendramodi.in/te/when-development-ensures-dignity-14-march-2019-544034> (accessed November 1, 2019).
- Nigerian Electricity Regulatory Commission.** 2019. *ATC&C Losses*. <https://nerc.gov.ng/index.php/library/industry-statistics/distribution/119-atc-c-losses>.
- Niez, Alexandra.** 2010. "Comparative Study on Rural Electrification Policies in Emerging Economies." International Energy Agency Information Paper 2010/03.
- Pargal, Sheoli, and Sudeshna Ghosh Banerjee.** 2014. *More Power to India: The Challenge of Electricity Distribution*. Washington, DC: The World Bank.
- PowerLine.** 2018. *Looking Up: Utilities Report Overall Improvement in Operational Performance*. <https://powerline.net.in/2018/09/09/looking-up-2/> (accessed November 1, 2019).
- Prateek, Saumy.** 2018. "BERC Sets 4.16/kWh as Average Power Purchase Cost for Bihar DISCOMs." *MERCOM India*, March 23. <https://mercomindia.com/berc-power-purchase-cost-discoms/>.
- PTI.** 2018. "Over 70% Uday Bonds to Mature during 2019-27: Icra." *Money Control*, Nov 19. <https://www.moneycontrol.com/news/business/over-70-uday-bonds-to-mature-during-2019-27-icra-3197661.html>.
- Reddy, Amulya K., and Gladys D. Sumithra.** 1997. "Karnataka's Power Sector: Some Revelations." *Economic and Political Weekly* 32 (12): 585–600.
- Shaukat, Mahvish.** 2018. Too Close to Call: Electoral Competition and Politician Behavior in India. <https://economics.mit.edu/files/16553>.
- Sustainable Energy for All (SEFA).** 2012. *A Global Action Agenda: Pathways for Concerted Action toward Sustainable Energy for All*. Vienna: Sustainable Energy for All.
- Tongia, Rahul.** 2017. *Delhi's Household Electricity Subsidies: High and Inefficient*. New Delhi: Brookings India.
- Walsh, Mary Williams.** 2016. "How Free Electricity Helped Dig \$9 Billion Hole in Puerto Rico." *The New York Times*, February 1. <https://www.nytimes.com/2016/02/02/business/dealbook/puerto-rico-power-authorities-debt-is-rooted-in-free-electricity.html>.