

Ray of Hope? China and the Rise of Solar Energy

Yale 2023

Ignacio Banares-Sanchez¹, Robin Burgess¹, David Laszlo¹,
Pol Simpson¹, **John Van Reenen**^{1 2 3} Yifan Wang¹

¹ London School of Economics ² MIT ³ NBER

September 7, 2023

Outline

- 1 Introduction
- 2 Background
- 3 Data
- 4 Model
- 5 Empirical Strategy
- 6 Results

Outline

1 **Introduction**

2 Background

3 Data

4 Model

5 **Empirical Strategy**

6 Results

Clean energy essential to curbing emissions

- Around 73% of global greenhouse gas emissions are attributed to the energy sector
- Decarbonisation plans for many sectors reliant on electrification and therefore clean energy
- Emissions will grow if developing countries meet growing energy demand with fossil fuels

Cost of solar has fallen dramatically

Figure: Global average price of solar PV modules (in 2019 US\$ per Watt)

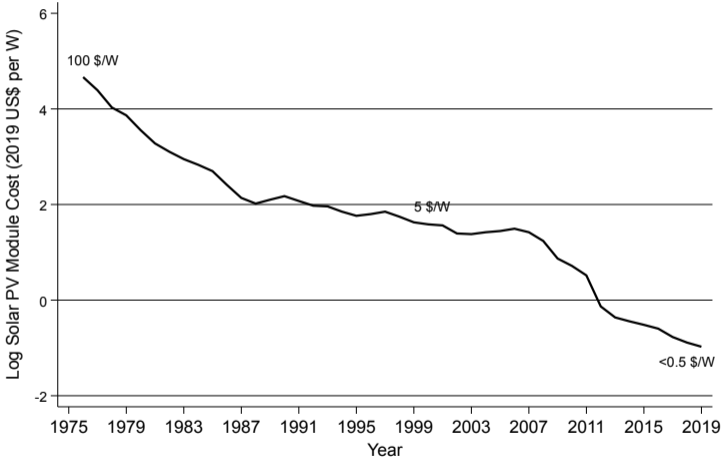

Source: LaFond et al. (2017) & IRENA Database

This Paper: Study impact of local subsidies on Chinese solar industry

- Chinese Solar PV had world-leading growth from mid-2000s onwards.

This Paper: Study impact of local subsidies on Chinese solar industry

- Chinese Solar PV had world-leading growth from mid-2000s onwards.
- Evaluate contribution of Chinese (place-based) industrial policy to this growth

This Paper: Study impact of local subsidies on Chinese solar industry

- Chinese Solar PV had world-leading growth from mid-2000s onwards.
- Evaluate contribution of Chinese (place-based) industrial policy to this growth
 - Industrial policy back in fashion: CHIPS Act, Inflation Reduction Act, European Green Deal, etc.

This Paper: Study impact of local subsidies on Chinese solar industry

- Chinese Solar PV had world-leading growth from mid-2000s onwards.
- Evaluate contribution of Chinese (place-based) industrial policy to this growth
 - Industrial policy back in fashion: CHIPS Act, Inflation Reduction Act, European Green Deal, etc.
- Retrieve policy text data from **PKULaw Database** (universe of laws and regulations in China, Wang and Yang, 2021) to classify solar subsidies: Production, Innovation, and Demand/installation (cf. Juhasz et al., 2022)

This Paper: Study impact of local subsidies on Chinese solar industry

- Chinese Solar PV had world-leading growth from mid-2000s onwards.
- Evaluate contribution of Chinese (place-based) industrial policy to this growth
 - Industrial policy back in fashion: CHIPS Act, Inflation Reduction Act, European Green Deal, etc.
- Retrieve policy text data from **PKULaw Database** (universe of laws and regulations in China, Wang and Yang, 2021) to classify solar subsidies: Production, Innovation, and Demand/installation (cf. Juhasz et al., 2022)
- Implement Synthetic DID approach (Arkhangelsky et al., 2021) exploiting introduction of city-level in solar policies over time

This Paper: Study impact of local subsidies on Chinese solar industry

- Chinese Solar PV had world-leading growth from mid-2000s onwards.
- Evaluate contribution of Chinese (place-based) industrial policy to this growth
 - Industrial policy back in fashion: CHIPS Act, Inflation Reduction Act, European Green Deal, etc.
- Retrieve policy text data from **PKULaw Database** (universe of laws and regulations in China, Wang and Yang, 2021) to classify solar subsidies: Production, Innovation, and Demand/installation (cf. Juhasz et al., 2022)
- Implement Synthetic DID approach (Arkhangelsky et al., 2021) exploiting introduction of city-level in solar policies over time
- Gather rich new micro-data on universe of solar panel manufacturers in China & including their production (in MWh) from ENF. Match to business register, patents (SIPO, PATSTAT, etc.), customs (exports), Orbis (revenue, labor, capital, productivity), ASIE, etc.

Preview of Results

- Innovation & Production subsidies both generate more city-wide solar **innovation** (e.g. citation weighted patents)

Preview of Results

- Innovation & Production subsidies both generate more city-wide solar **innovation** (e.g. citation weighted patents)
- Policies also increased **productivity, firm numbers, production capacity, revenues and exports**

Preview of Results

- Innovation & Production subsidies both generate more city-wide solar **innovation** (e.g. citation weighted patents)
- Policies also increased **productivity, firm numbers, production capacity, revenues and exports**
- Local impacts weaker for demand policies, likely because panels can be sourced from other Chinese cities (cf. German feed-in tariffs after 2000)

Preview of Results

- Innovation & Production subsidies both generate more city-wide solar **innovation** (e.g. citation weighted patents)
- Policies also increased **productivity, firm numbers, production capacity, revenues and exports**
- Local impacts weaker for demand policies, likely because panels can be sourced from other Chinese cities (cf. German feed-in tariffs after 2000)
- Data consistent with new model integrating multi-region energy demand, heterogeneous manufacturers with endogenous R&D and exporting decisions.

Preview of Results

- Innovation & Production subsidies both generate more city-wide solar **innovation** (e.g. citation weighted patents)
- Policies also increased **productivity, firm numbers, production capacity, revenues and exports**
- Local impacts weaker for demand policies, likely because panels can be sourced from other Chinese cities (cf. German feed-in tariffs after 2000)
- Data consistent with new model integrating multi-region energy demand, heterogeneous manufacturers with endogenous R&D and exporting decisions.
- Extensions: Business stealing dominated by positive spillovers; some effects via learning by-doing

Preview of Results

- Innovation & Production subsidies both generate more city-wide solar **innovation** (e.g. citation weighted patents)
- Policies also increased **productivity, firm numbers, production capacity, revenues and exports**
- Local impacts weaker for demand policies, likely because panels can be sourced from other Chinese cities (cf. German feed-in tariffs after 2000)
- Data consistent with new model integrating multi-region energy demand, heterogeneous manufacturers with endogenous R&D and exporting decisions.
- Extensions: Business stealing dominated by positive spillovers; some effects via learning by-doing
- Preliminary analysis suggests benefits much larger than costs

Some Existing Literature

- **Industrial Policy: Theory:** Rodrik (2004); Harrison & Rodriguez-Clare (2010) survey; Liu (2019); Bartelme et al. (2021), Buera et al. (2013); Itskhoki & Moll (2019); Murphy et al. (1989)
- **Industrial Policy: Empirics (inc. LBD):** Lane (2020, 2021); Criscuolo et al. (2019); Juhasz et al. (2022); Choi & Levchenko (2021); Choi & Shim (2022); Levitt et al. (2013); Liu & Song (2022)
- **(Green) Directed Technical Change:** Aghion et al. (2016); Acemoglu et al. (2012, 2016, 2019); Arkolakis & Walsh (2023); Popp (2022, 2019); Newell et al. (1999)
- **Chinese Growth & Policy:** Kalouptsidi (2018); Barwick, Kalouptsidi and Zahur (2021); Aghion et al. (2015); Bai et al. (2019); Ball et al. (2017); Chen & Xie (2019); Wang & Yang (2021), Song et al. (2011); Konig, Lorenz & Zilibotti (2021); Wei et al. (2023)
- **Solar:** Bollinger & Gillingham (2021); Gerarden (2022); Gillingham & Tsvetanov (2019); de Groote & Verboven (2019); Nemet (2019);
- **Technology and Trade:** Melitz & Redding (2023); Bustos (2011); Coelli, Ulltveit-Moe & Moxnes (2020); Aghion et al. (2017)
- **Place-Based Policies:** Moretti (2011, 2012); Kline (2010); Gruber & Johnson (2019); Greenstone et al. (2010); Kline & Moretti (2014)

Outline

① Introduction

② **Background**

③ Data

④ Model

⑤ Empirical Strategy

⑥ Results

From cell to panels

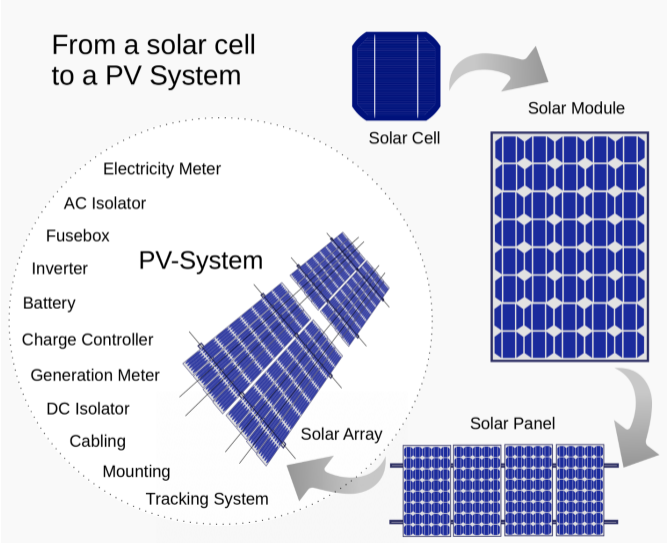

Renewable electricity capacity, especially solar, has grown rapidly...

Figure: World electricity production by source

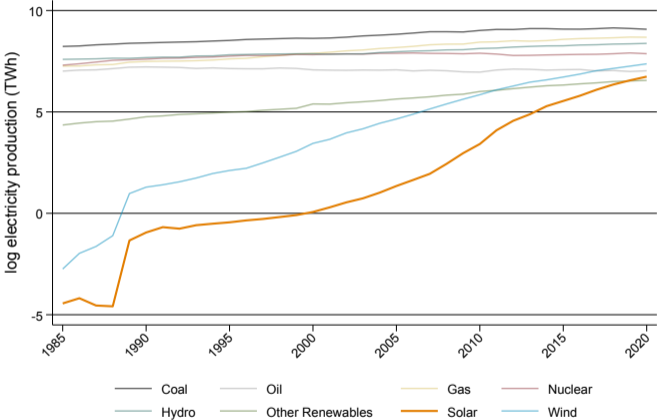

Source: International Energy Agency (IEA)

Shares

..Especially in some countries like China and Chile

Figure: Installed Electricity generation capacity in China and Chile by source

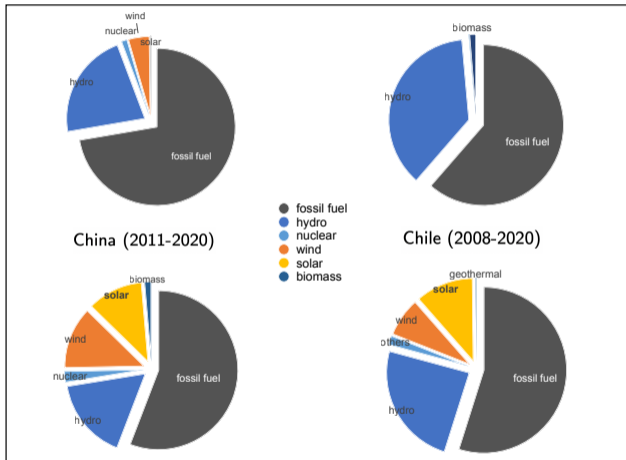

Source: State Grid New Energy Cloud & CNE

- **World, 2011 to 2020:** installed solar capacity went from 0.8% to 6.8%
- **China, 2011 to 2020:** installed solar capacity went from 0.19% to 11.35%
- **Chile, 2008 to 2020:** installed solar capacity went from 0% to 12%

Huge fall in cost of solar relative to other energy sources (1880-2020)

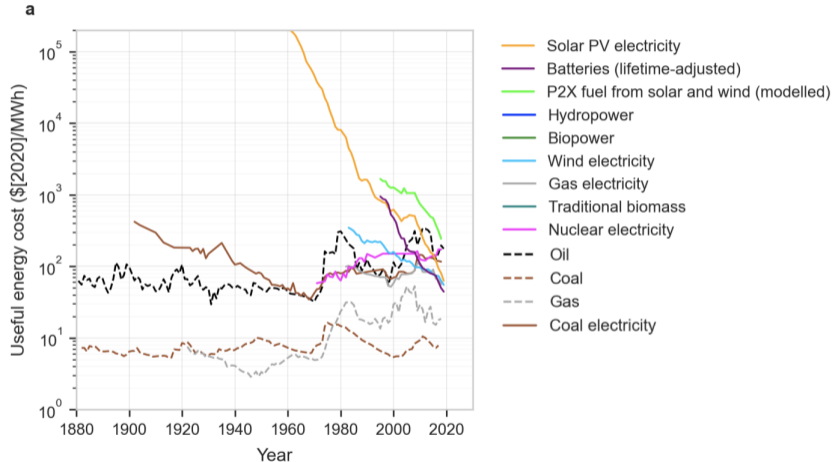

Source: Way, Ives, Mealy and Farmer (2021) "Empirically grounded technology forecasts and the energy transition"

Solar price falls were much faster than forecast (1980-2030)

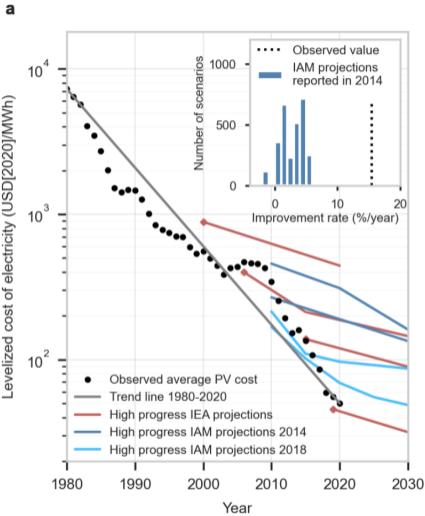

Source: Way, Ives, Mealy and Farmer (2021) "Empirically grounded technology forecasts and the energy transition"

China's global share of solar production rose from near zero to 60% in the decade to 2013

Figure: Share of Annual Solar Photovoltaics Cell Production in Leading Countries, 2000-2013

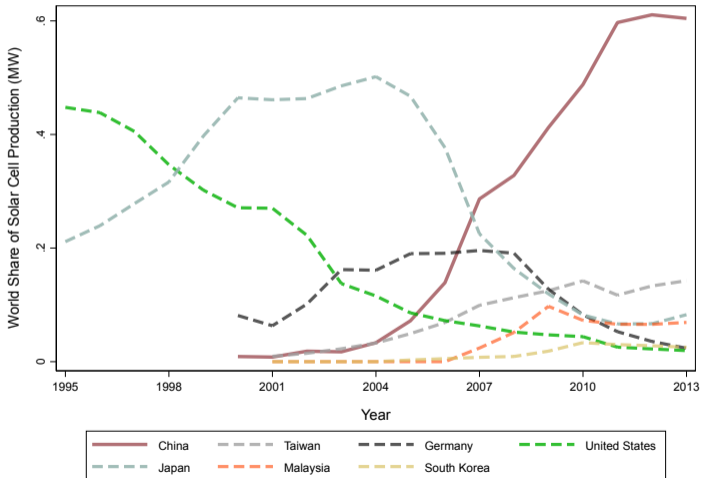

Note: The original data was compiled by the Earth Policy Institute from GTM Research, PV Cell Module Production Data, electronic database, updated June 2014.

And this was in context of huge growth in solar production

Figure: Solar PV cell production 2000-2013

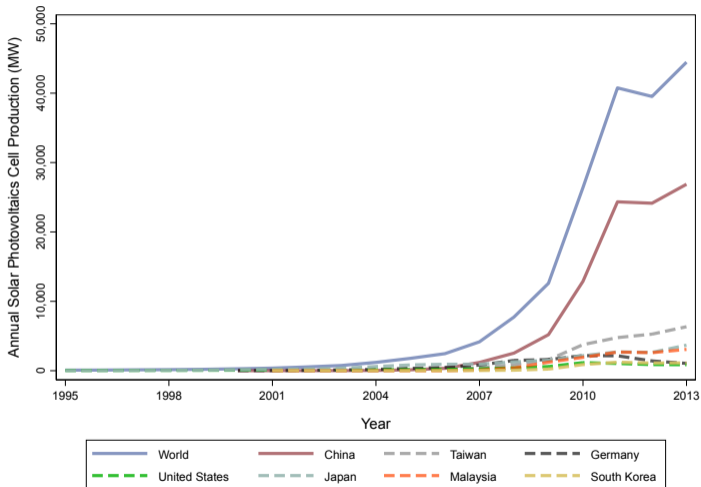

Note: The original data was compiled by the Earth Policy Institute from GTM Research, PV Cell Module Production Data, electronic database, updated June 2014.

China's rise in solar shipments has continued in later years

Figure: Solar PV module shipments (GW) by country of origin, 2010-2019

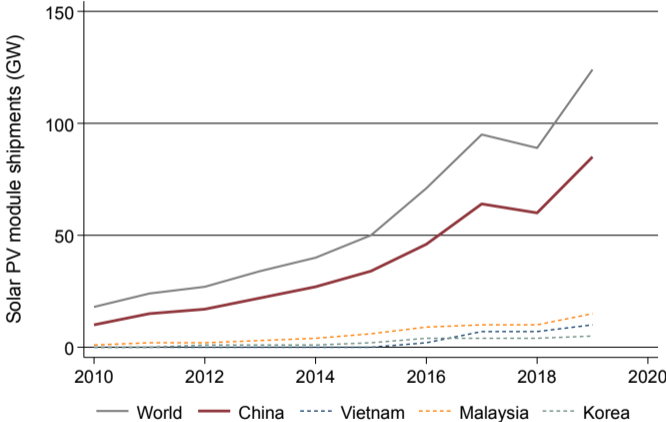

Source: International Energy Agency (IEA)

China is not just imitating: Huge growth in Solar Patents

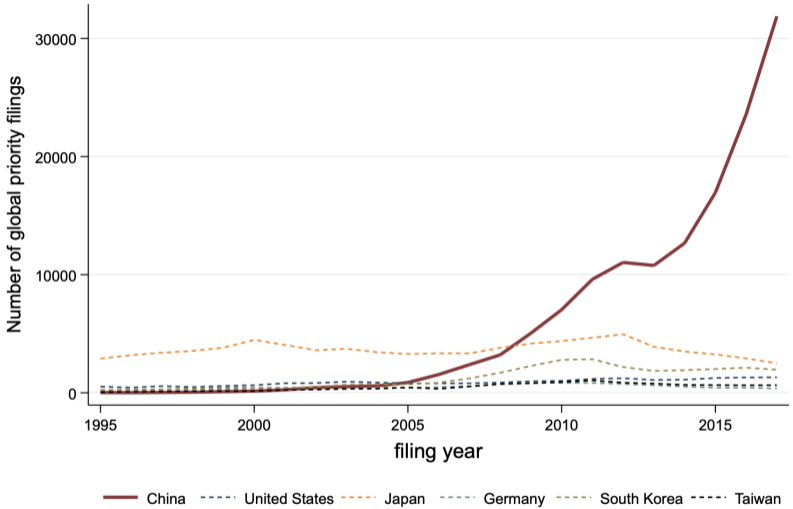

Source: PATSTAT - solar patents based on IPC/CPC

codes
Citations Triadic Patents

China is not just imitating: Citation-Weighted Solar Patents

Figure: Cite-weighted Chinese solar patents

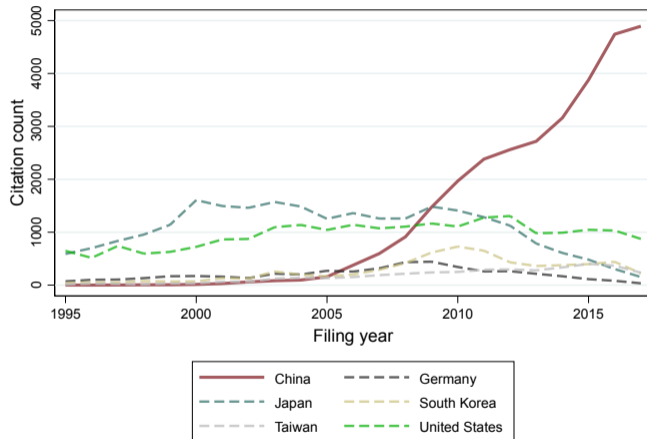

Note: Total yearly citations are divided by the number of years since the patent's filing to adjust for differences in the number of years when patents can be cited.

Source: PATSTAT database: Patents by priority date in all patent offices.

China is not just imitating: Triadic Solar Patents

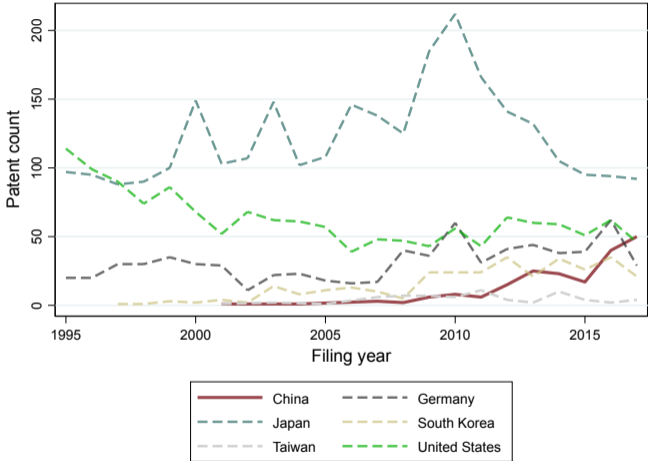

Source: PATSTAT database, Triadic patents = filed in USPTO, EPO and JPO

China is innovating not just imitating: Technological Frontier

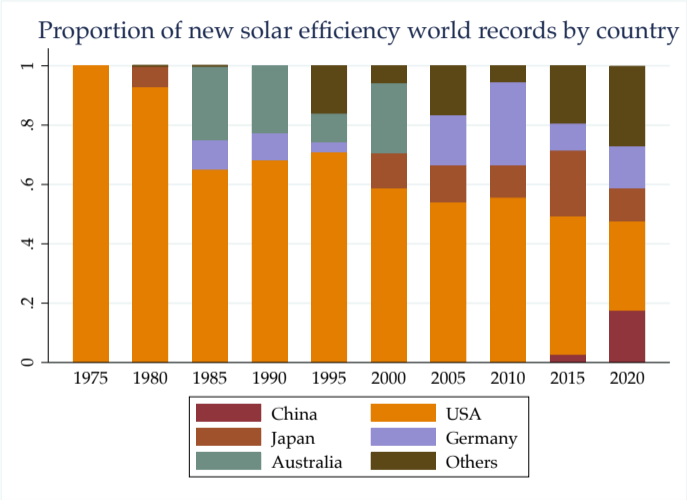

Source: Solar World Record Database

Coincides with expansion of solar industrial policy in China

Figure: Number of new solar-related policies

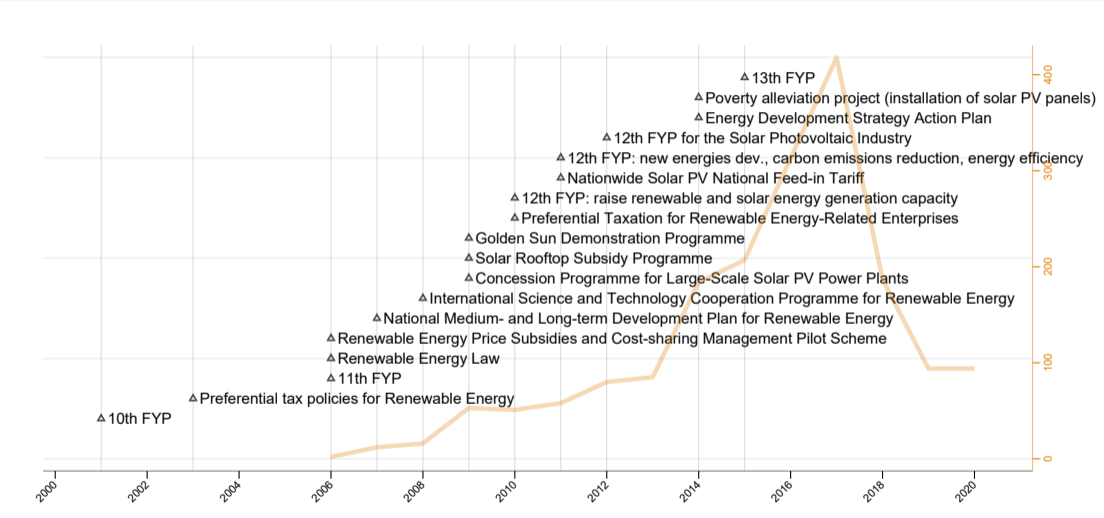

Source: PKU Law



Much of this industrial policy was led by local government

- Industry histories suggest important role of local government (Ball et al. 2017; Chen, 2016)
- City governments have significant policy autonomy (Text of policy documents makes this clear)
- City governments have budget to implement meaningful industrial policies (Bai, Hsieh, and Song, 2019)
- Local bureaucrats have strong incentives to promote economic growth e.g. career concerns (Jia et al 2015)

Outline

① Introduction

② Background

③ **Data**

④ Model

⑤ Empirical Strategy

⑥ Results

We need to measure

- **Treatment:** Solar industrial policies at the city level
- **Outcomes:** Combined activity of new / existing solar firms in a given city-year
 - Innovation
 - Outputs and Inputs
 - Exports

Measure solar industrial policy using PKULaw Database

- Use key words to extract solar policies from database of all laws, regulations and policies in China

Measure solar industrial policy using PKULaw Database

- Use key words to extract solar policies from database of all laws, regulations and policies in China
- Identify financial subsidies based on text (with quantitative info)

Measure solar industrial policy using PKULaw Database

- Use key words to extract solar policies from database of all laws, regulations and policies in China
- Identify financial subsidies based on text (with quantitative info)
- Distinguish subsidies into: (i) Demand (ii) Production and (iii) Innovation

Measure solar industrial policy using PKULaw Database

Table: City-level solar policies

Type of policy	Number	Example
Subsidy	78	
1. Production subsidy	27	<i>"The cost of a new solar production line built in Hefei will be subsidized by 12% (2018)"</i>
2. Innovation subsidy	12	<i>"Firms will be awarded 10,000 RMB if they earn provincial level R&D center certification (Guilin, 2011)"</i>
3. Demand subsidy	61	<i>"1 RMB per watt for the electricity generated by solar projects installed in Beijing (2010)"</i>

Source: Own analysis using PKULaw data

Measure solar industrial policy using PKULaw Database

- For each policy we observe implementing authority (city vs. province vs. national) and date
- Focus on treatment at the city level: first year the city implements a solar subsidy

Time series of policy support

Figure: Number of cities treated with supply & demand subsidies

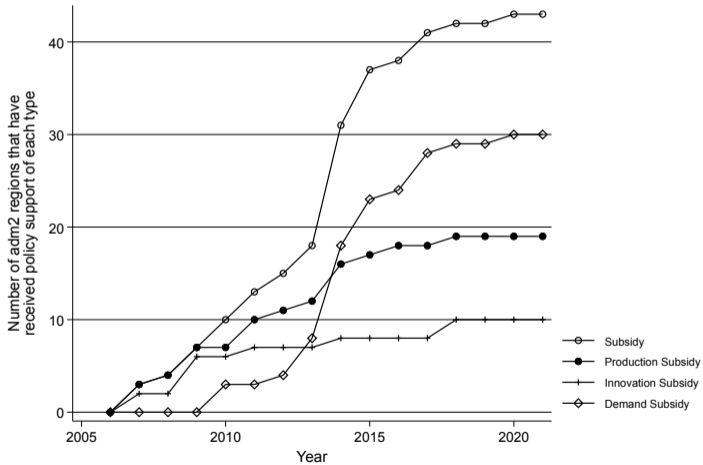

We study the outcomes of solar panel manufacturers

- We define the solar industry as the set of firms who produce solar panels

We study the outcomes of solar panel manufacturers

- We define the solar industry as the set of firms who produce solar panels
- Sample from **ENF Solar**, the largest online solar directory worldwide



Company Directory

	Panels	1,860
	Components	4,822
	Equipment	805
	Materials	2,043
	Sellers	3,514
	Installer	46,430
	Software	385

Featured Product

Solar Panels

 From **£0.169 / Wp**

SL5M144 535-550W

SunLink PV

Power Range: 535 ~ 550 Wp

Panel Efficiency: 20.7 ~ 21.3 %

Panel Dimension (H/W/D): 2279x1134x35 mm

- 1. Higher Power Density
- 2. SEMI+MBB
- 3. Lighter but More Reliable
- 4. Applied Under Strict Conditions

[View Product](#)

Product Directory

	Solar Panels	44,135
	Solar Inverters	15,084
	Mounting Systems	2,727
	Charge Controller	2,889
	Storage Systems	14,516
	Solar Cells	4,273
	Encapsulants	133
	Backsheets	163



ENF Featured Sub-Categories

[More Details](#)

We study the outcomes of solar panel manufacturers

- We define the solar industry as a set of firms who manufacture solar panels
- Sample from **ENF Solar**, the largest online solar directory worldwide
- Identify 1,718 solar panel manufacturers in China (2004-2020)

We study the outcomes of solar panel manufacturers

- We define the solar industry as a set of firms who manufacture solar panels
- Sample from **ENF Solar**, the largest online solar directory worldwide
- Identify 1,718 solar panel manufacturers in China (2004-2020)
- Cross-referencing aggregate statistics suggests we capture the whole industry

Aggregating the firm data gives us outcomes at the city-year level

- **Innovation:** All patents filed by solar firms in city-year (text, citations, etc.) [Example patents](#)
- **Revenues:** Total revenues (and employment, capital, etc.)
- **Production capacity:** Total MWh capacity of all solar panels manufactured
- **Firm count:** Number of solar firms
- **Exports:** Total Exports (values, volume, etc.)

[Descriptive Statistics](#)

[Validation with ASIE](#)

Coverage of Data across years

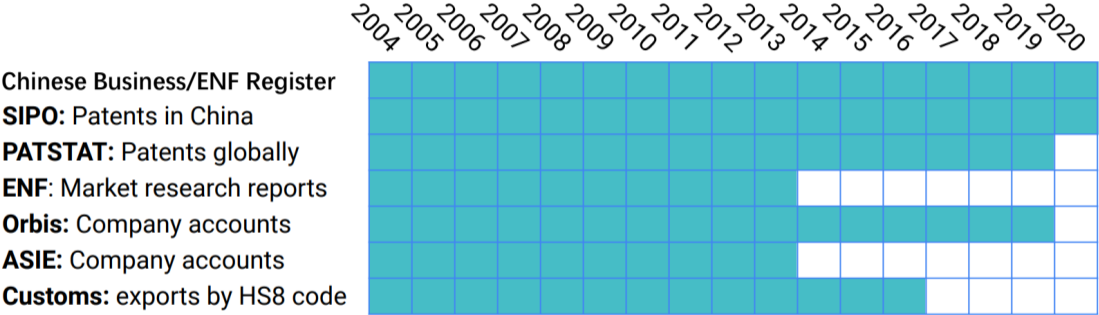

Chinese Solar industry evolution

Panel A: All patents

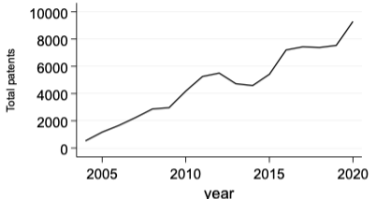

Panel B: Firm count

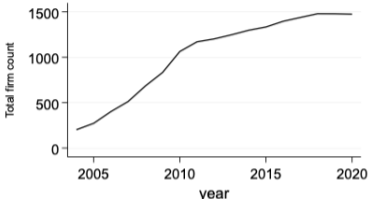

Panel C: Revenue

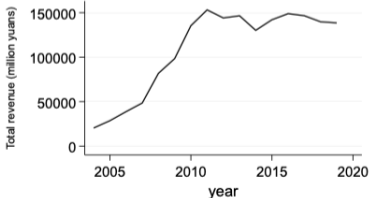

Panel D: Panel capacity

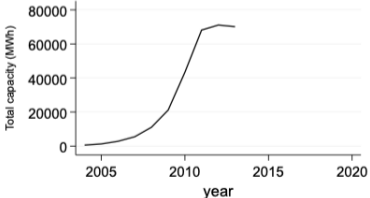

Our analysis compares policy and outcomes at the city level

Here: patent counts and any subsidy

2000

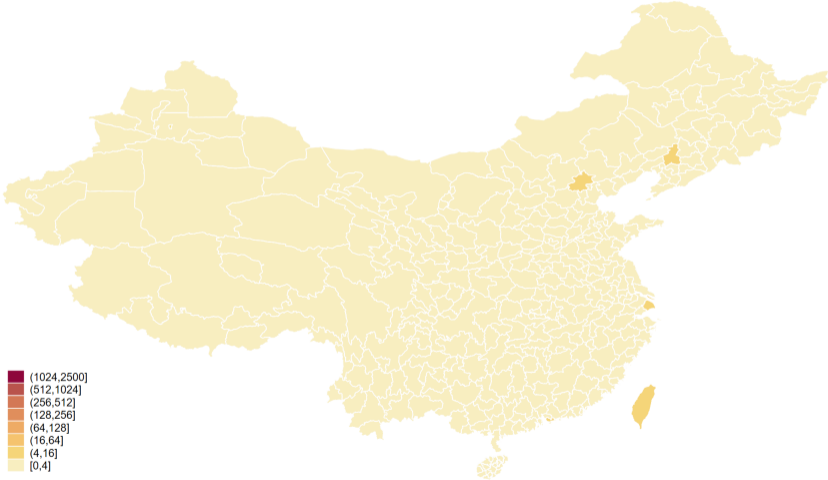

Note: black circled cities are treated by any subsidy policy

Our analysis compares policy and outcomes at the city level

Here: patent counts (subsidy in black circles)

2001

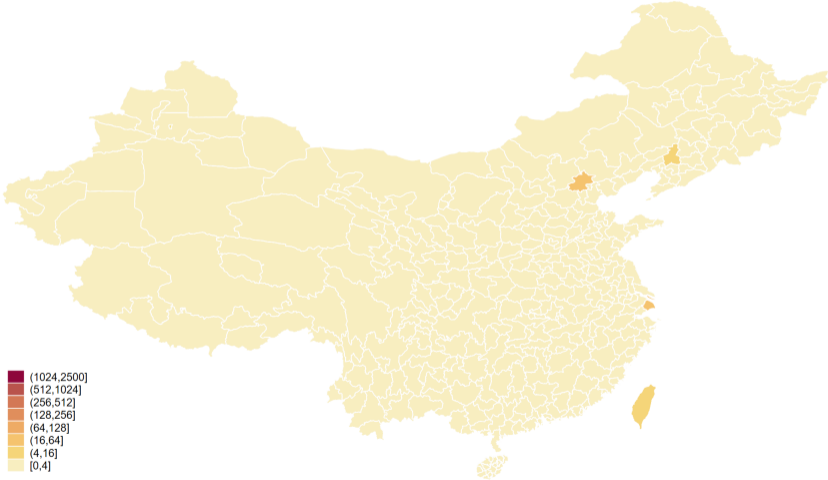

Note: black circled cities are treated by any subsidy policy

Our analysis compares policy and outcomes at the city level

Here: patent counts and any subsidy

2002

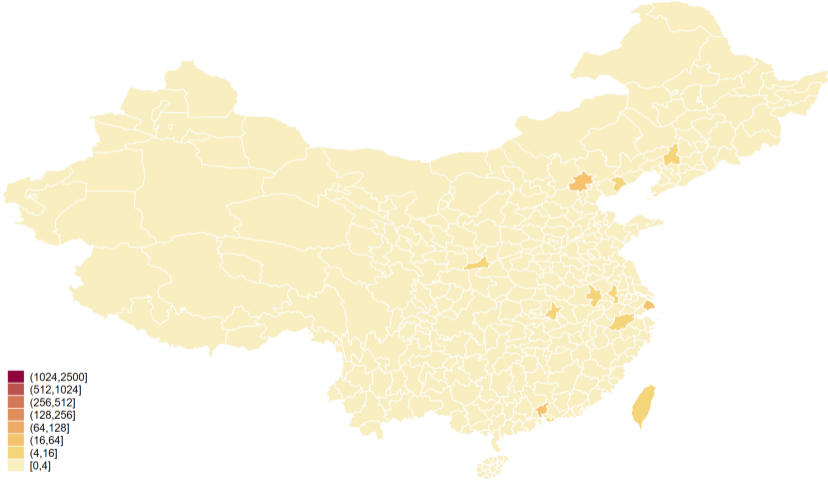

Note: black circled cities are treated by any subsidy policy

Our analysis compares policy and outcomes at the city level

Here: patent counts and any subsidy

2003

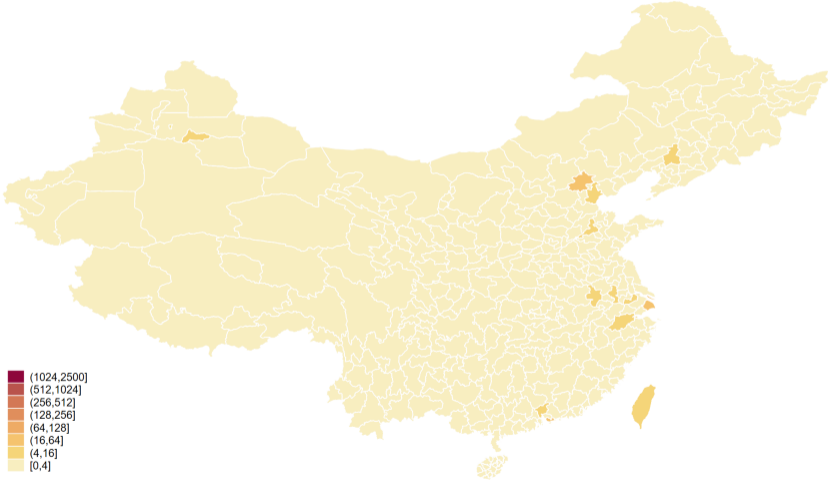

Note: black circled cities are treated by any subsidy policy

Our analysis compares policy and outcomes at the city level

Here: patent counts and any subsidy

2004

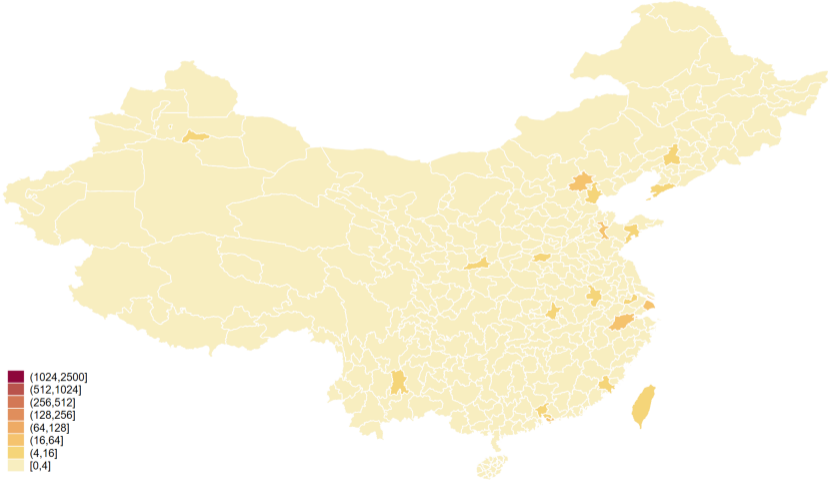

Note: black circled cities are treated by any subsidy policy

Our analysis compares policy and outcomes at the city level

Here: patent counts and any subsidy

2005

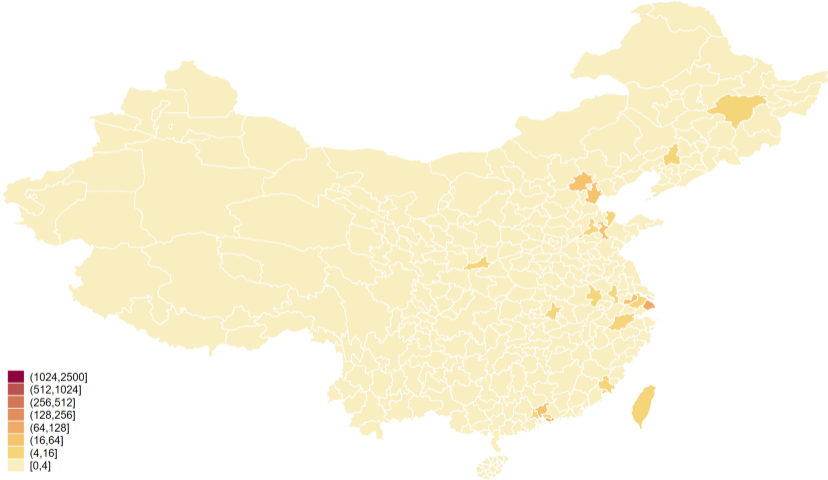

Note: black circled cities are treated by any subsidy policy

Our analysis compares policy and outcomes at the city level

Here: patent counts and any subsidy

2006

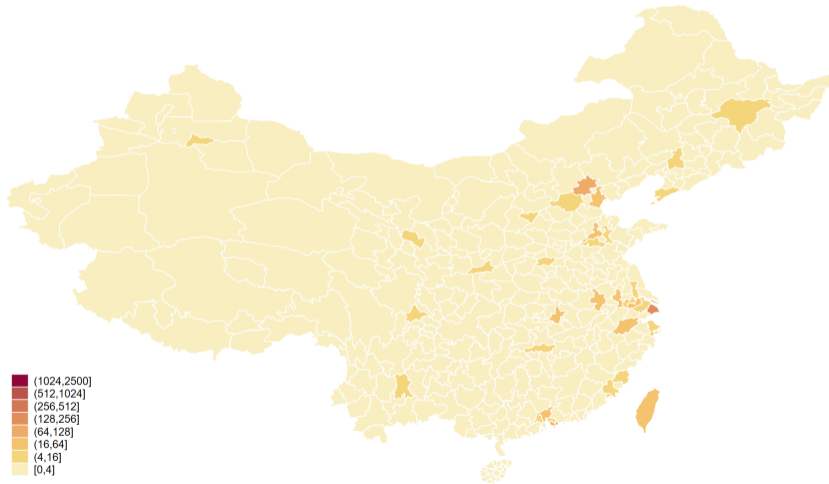

Note: black circled cities are treated by any subsidy policy

Our analysis compares policy and outcomes at the city level

Here: patent counts and any subsidy

2007

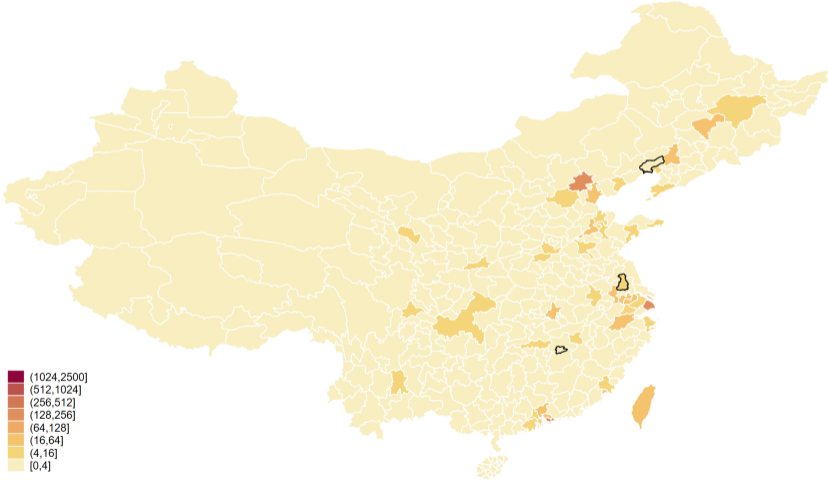

Note: black circled cities are treated by any subsidy policy

Our analysis compares policy and outcomes at the city level

Here: patent counts and any subsidy

2008

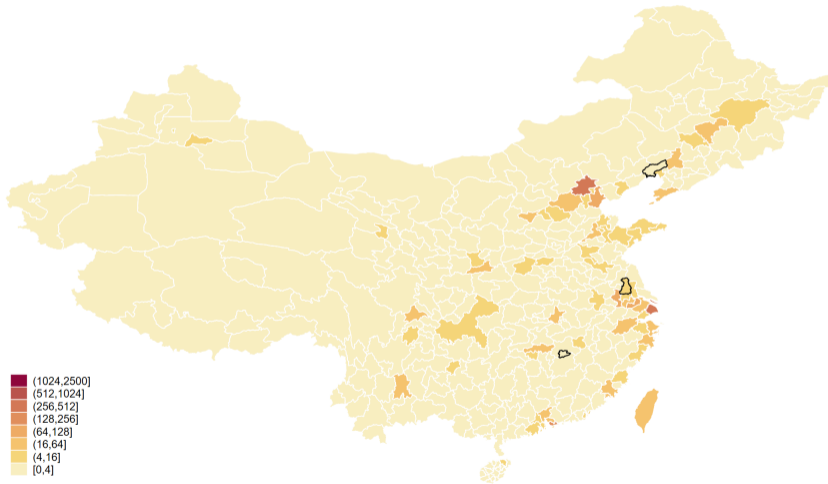

Note: black circled cities are treated by any subsidy policy

Our analysis compares policy and outcomes at the city level

Here: patent counts and any subsidy

2009

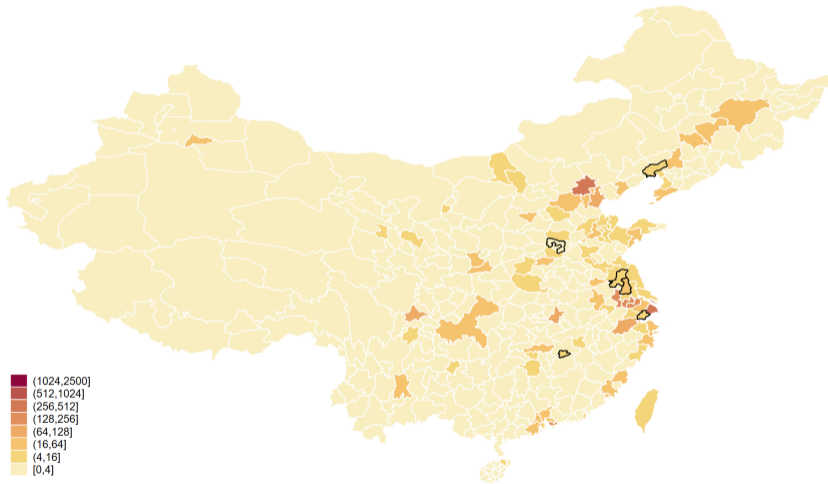

Note: black circled cities are treated by any subsidy policy

Our analysis compares policy and outcomes at the city level

Here: patent counts and any subsidy

2010

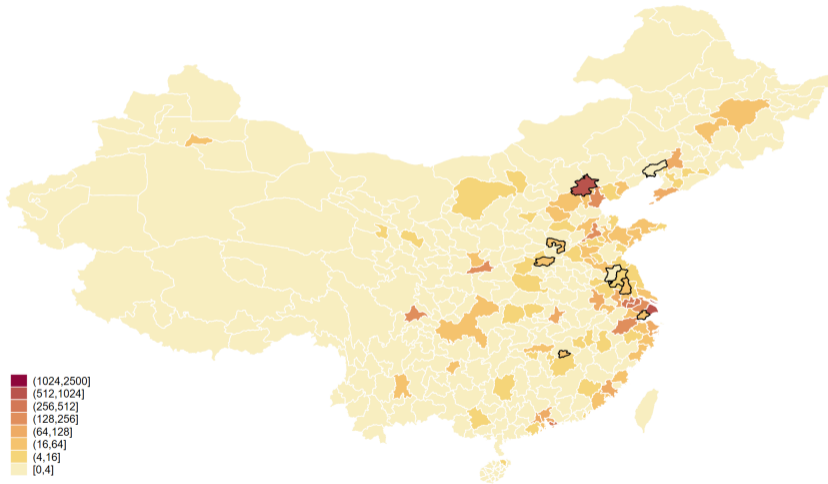

Note: black circled cities are treated by any subsidy policy

Our analysis compares policy and outcomes at the city level

Here: patent counts and any subsidy

2011

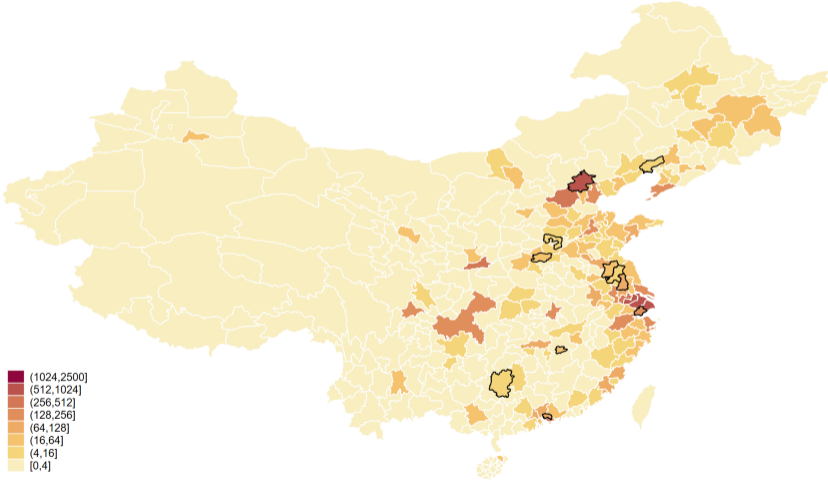

Note: black circled cities are treated by any subsidy policy

Our analysis compares policy and outcomes at the city level

Here: patent counts and any subsidy

2012

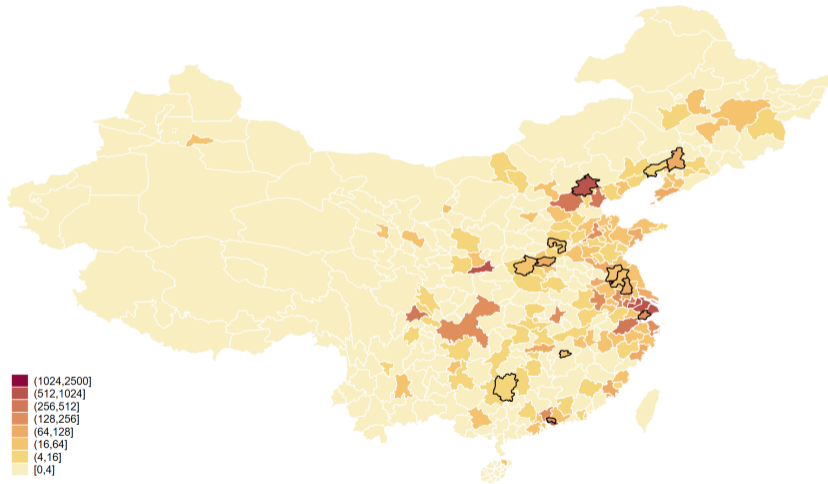

Note: black circled cities are treated by any subsidy policy

Our analysis compares policy and outcomes at the city level

Here: patent counts and any subsidy

2013

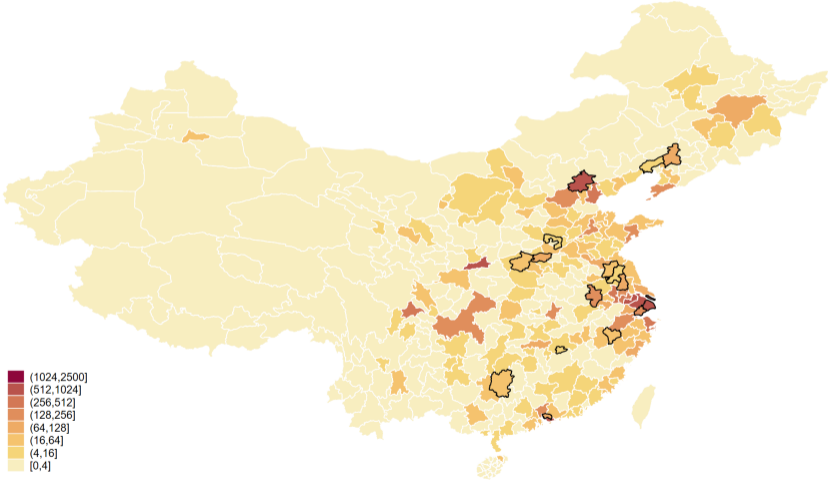

Note: black circled cities are treated by any subsidy policy

Our analysis compares policy and outcomes at the city level

Here: patent counts and any subsidy

2014

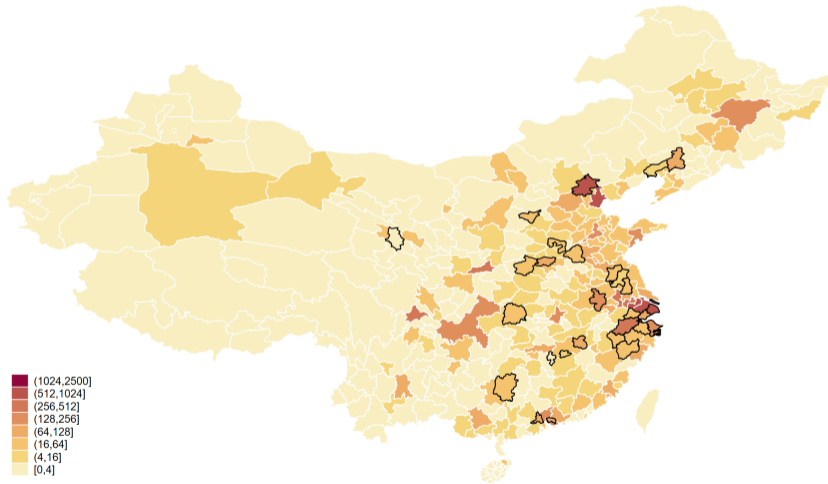

Note: black circled cities are treated by any subsidy policy

Our analysis compares policy and outcomes at the city level

Here: patent counts and any subsidy

2015

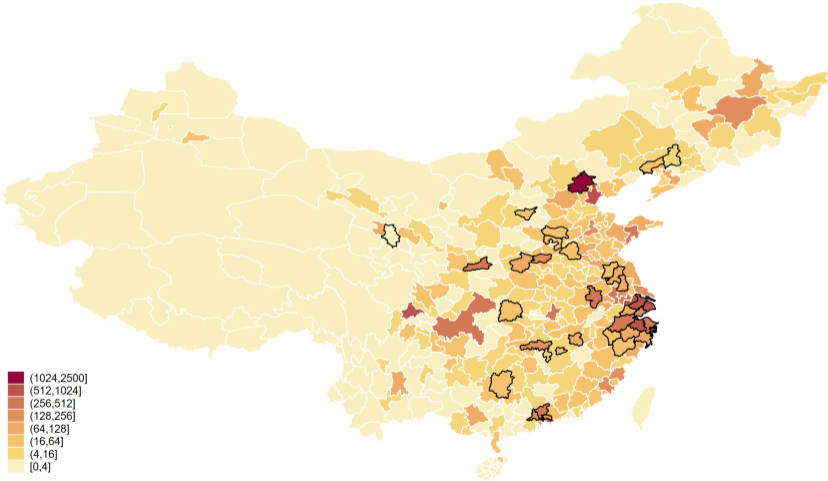

Note: black circled cities are treated by any subsidy policy

Our analysis compares policy and outcomes at the city level

Here: patent counts and any subsidy

2016

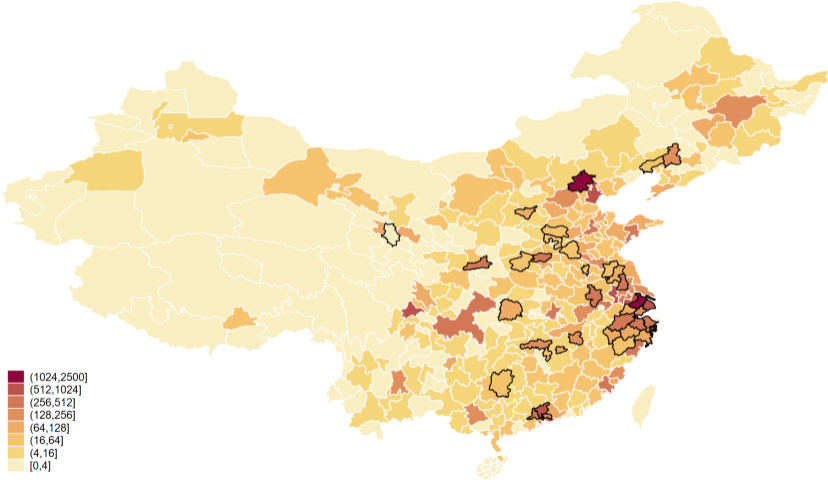

Note: black circled cities are treated by any subsidy policy

Our analysis compares policy and outcomes at the city level

Here: patent counts and any subsidy

2017

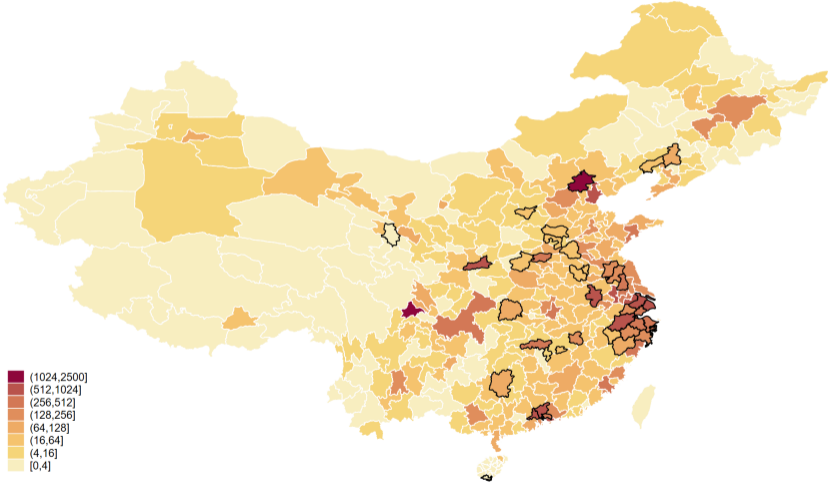

Note: black circled cities are treated by any subsidy policy

Our analysis compares policy and outcomes at the city level

Here: patent counts and any subsidy

2018

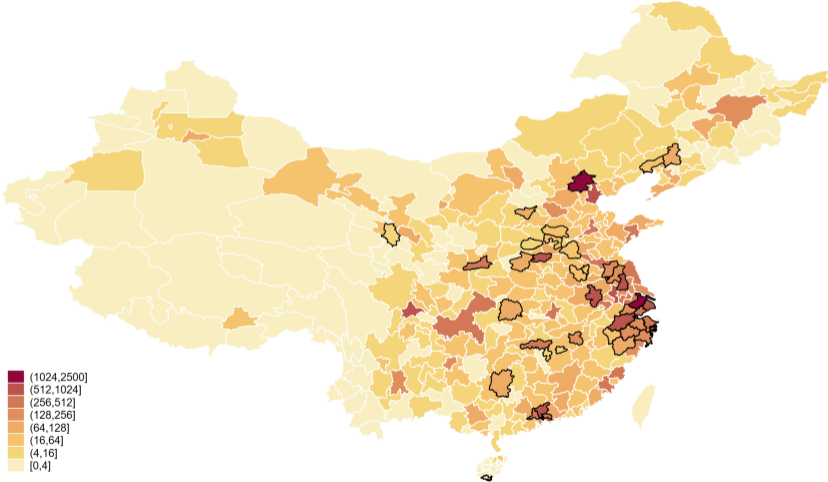

Note: black circled cities are treated by any subsidy policy

Our analysis compares policy and outcomes at the city level

Here: patent counts and any subsidy

2019

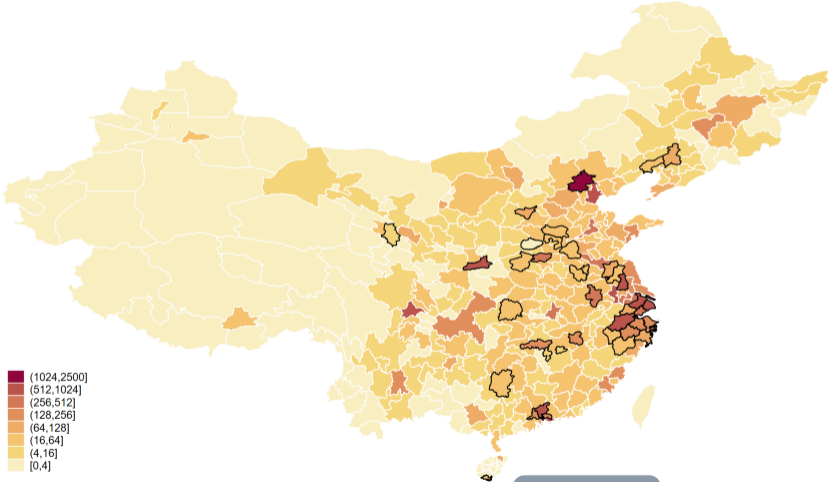

Note: black circled cities are treated by any subsidy policy

Spatial Concentration

Outline

① Introduction

② Background

③ Data

④ **Model**

⑤ Empirical Strategy

⑥ Results

Research Questions

- Does the introduction of subsidies increase **innovation**?

Research Questions

- Does the introduction of subsidies increase **innovation**?
- Does the introduction of subsidies increase **output**?

Research Questions

- Does the introduction of subsidies increase **innovation**?
- Does the introduction of subsidies increase **output**?
- Does the introduction of subsidies increase **exports**?

Research Questions

- Does the introduction of subsidies increase **innovation**?
- Does the introduction of subsidies increase **output**?
- Does the introduction of subsidies increase **exports**?
- How do the effects differ by subsidy type: demand, production, innovation?

Causal Graph

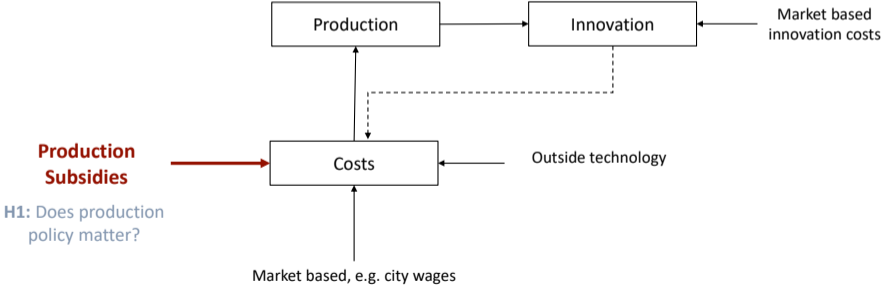

Causal Graph

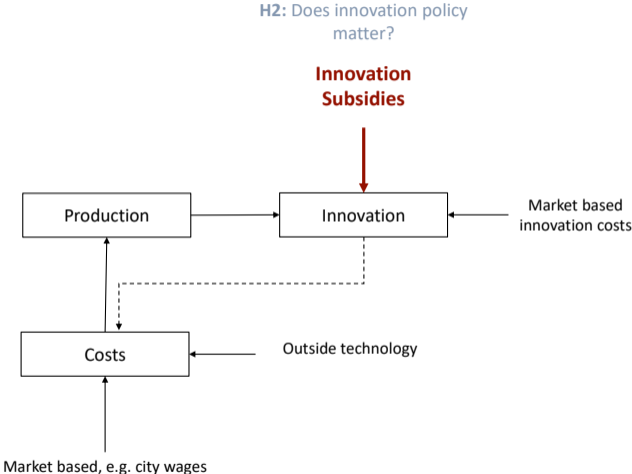

Data

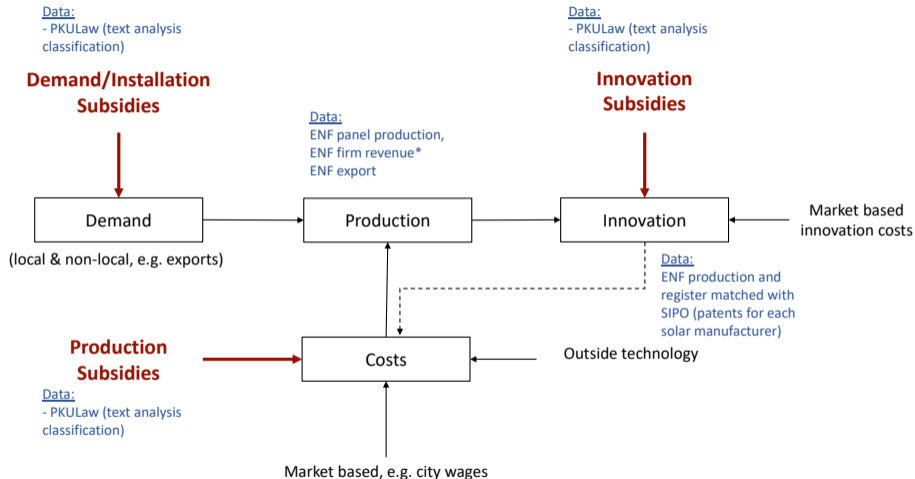

Firm count: ENF register matched with Chinese firm registration platform (firm entry and exit dates for each solar manufacturer)

*ENF firm revenue: ENF register matched with Orbis platform

Model

Electricity generation using manufactured inputs

- Heterogenous firms model (power plant components manufacturers)
- Economy: many cities within China, plus one 'foreign' location
- Representative consumer in each region demands electricity services (CES solar & non-solar)
- Local "Grid Planner" builds solar and non-solar power plants using components (e.g. solar panels) sourced from manufacturers in all Chinese cities, subject to transport costs
- Manufacturers make endogenous **entry, exit, production, exporting, and technology upgrading** (innovation) decisions
- Model provides intuition for impacts of place-based subsidies

Timing of Decisions

- 1 Entrepreneurs enter by paying a sunk cost, then draw productivity. Decide whether to exit.
- 2 If continue, decide whether to pay fixed cost of innovation to further reduce marginal cost.
- 3 Then decide whether to export (another fixed cost) or just serve domestic Chinese market (Melitz, 2003)
- 4 These fixed costs help determine productivity cut-offs for: (i) production, (ii) exporting and (iii) innovation.
- 5 Producing firms in origin city o serve multiple destination cities d paying iceberg trade costs
- 6 Demand for intermediates across all Chinese cities from different grid planners (and overseas) influences solar manufacturer decisions.

Demand for energy sources

- In each destination city d , representative consumer utility from electricity services e_d (e.g. from solar farms):

$$U_d = u(e_d) \quad (1)$$

- Electricity services installed in each city-region by Grid Planner, who builds power plants combining output from a clean sector (s) and dirty energy sector (s'), e.g. solar vs. coal:

$$e_d = \left(\kappa_{d,s} e_{d,s}^\rho + \kappa_{d,s'} e_{d,s'}^\rho \right)^{1/\rho} \quad (2)$$

Demand for energy sector manufactured inputs

(e.g. solar panels)

- To generate output for each energy sector, Grid Planner in city d combines intermediate inputs, $q_{od,s}(\omega)$ = quantity of variety ω manufactured in city o supplied to d using CES:

$$e_{d,s} = \left(\sum_o \int_{\omega \in \Omega_{o,s}} q_{od,s}(\omega)^{\frac{\sigma_s - 1}{\sigma_s}} d\omega \right)^{\frac{\sigma_s}{\sigma_s - 1}} \quad (3)$$

Demand for energy sector manufactured inputs

(e.g. solar panels)

- To generate output for each energy sector, Grid Planner in city d combines intermediate inputs, $q_{od,s}(\omega)$ = quantity of variety ω manufactured in city o supplied to d using CES:

$$e_{d,s} = \left(\sum_o \int_{\omega \in \Omega_{o,s}} q_{od,s}(\omega)^{\frac{\sigma_s-1}{\sigma_s}} d\omega \right)^{\frac{\sigma_s}{\sigma_s-1}} \quad (3)$$

- Grid planner supplies as much energy as possible in the minimal cost way given income of representative consumer, I_d

$$\begin{aligned} \max_{e_{d,s}, e_{d,s'}} & \left(\kappa_{d,s'} e_{d,s'}^\rho + \kappa_{d,s} e_{d,s}^\rho \right)^{1/\rho} \\ \text{s.t.} & P_{d,s} e_{d,s} + P_{d,s'} e_{d,s'} = I_d \end{aligned}$$

Demand for energy sector manufactured inputs

(e.g. solar panels)

- To generate output for each energy sector, Grid Planner in city d combines intermediate inputs, $q_{od,s}(\omega)$ = quantity of variety ω manufactured in city o supplied to d using CES:

$$e_{d,s} = \left(\sum_o \int_{\omega \in \Omega_{o,s}} q_{od,s}(\omega)^{\frac{\sigma_s-1}{\sigma_s}} d\omega \right)^{\frac{\sigma_s}{\sigma_s-1}} \quad (3)$$

- Grid planner supplies as much energy as possible in the minimal cost way given income of representative consumer, I_d

$$\begin{aligned} \max_{e_{d,s}, e_{d,s'}} & \left(\kappa_{d,s'} e_{d,s'}^\rho + \kappa_{d,s} e_{d,s}^\rho \right)^{1/\rho} \\ \text{s.t.} & P_{d,s} e_{d,s} + P_{d,s'} e_{d,s'} = I_d \end{aligned}$$

- Which yields our solar installation demand function, e_s^* :

$$e_{d,s}^*(P_{d,s}, P_{d,s'}, I_d) = \left(\frac{\kappa_{d,s}}{P_{d,s}} \right)^\sigma \frac{I_d}{\kappa_{d,s'}^\sigma P_{d,s'}^{1-\sigma} + \kappa_{d,s}^\sigma P_{d,s}^{1-\sigma}}; \quad (4)$$

where $\sigma = 1/(1 - \rho)$

Demand for Energy manufactured inputs (e.g. solar PV modules)

- To meet the optimal energy demand, grid planner chooses solar modules from all cities given their prices, $p_{od,s}$. This will determine price indices $P_{d,s}$ and $P_{d,s'}$.
- Solving this constrained optimization problem gives a demand for each variety:

$$q_{od,s}(\omega) = \left(\frac{p_{od,s}(\omega)}{P_{d,s}} \right)^{-\sigma_s} \left(\frac{\kappa_{d,s}}{P_{d,s}} \right)^\sigma \frac{I_d}{\kappa_{d,s'}^\sigma P_{d,s'}^{1-\sigma} + \kappa_{d,s}^\sigma P_{d,s}^{1-\sigma}} \quad (5)$$

Solar Panel manufacturing technology

Production decision:

- Firms use a composite factor of production $L_{o,s}$ with unit cost $w_{o,s}$
- They need to pay a sunk cost $w_{o,s}f_{o,s}^e$ to enter
- After paying this cost, they draw productivity φ , from Pareto distribution
- To produce $q_{o,s}(\varphi)$ units of a variety, firm needs $f_{o,s} + \frac{q_{o,s}}{\varphi}$, where $f_{o,s}$ is fixed cost and $\frac{1}{\varphi}$ is marginal cost of production

Innovation decision:

- Upon observing its initial productivity φ , a firm can upgrade its technology (innovate)
- By incurring a fixed cost: $\eta_{o,s}f_{o,s}$, with $\eta_{o,s} > 1$, it reduces marginal cost to: $\frac{1}{\xi_{o,s}\varphi}$, with $\xi_{o,s} > 1$

Exporting and Prices

- Firms can sell to grid planners in China and overseas: both are subject to iceberg trade costs:
 - To serve market d , firm in o needs to produce $\tau_{od,s}q_{od,s}(\varphi)$ of variety, $\tau_{od,s} \geq 1$ (if $o = d$ then $\tau = 1$).
- There is a market access fixed cost for selling overseas (but not within China)
 - In order to serve overseas firm in o pays fixed cost $w_{o,s}f_{od,s}^x$
- Implies manufacturers' optimal prices are a constant markup over marginal costs

$$p_{od,s}(\varphi) = \frac{\sigma_s}{\sigma_s - 1} \frac{w_{o,s}\tau_{od,s}}{\xi_{o,s}\varphi} \quad (6)$$

Optimal Profits (3 regimes)

$$\begin{aligned} \Pi_{o,s}(\varphi) = \max & \left\{ \sum_{d \neq \tilde{d}} \left\{ \frac{(\sigma_s - 1)^{\sigma_s - 1}}{\sigma_s^{\sigma_s}} \frac{E_{d,s}}{(P_{d,s})^{1-\sigma_s}} \left(\frac{w_{o,s} \tau_{od,s}}{\varphi} \right)^{1-\sigma_s} \right\} - w_{o,s} f_{o,s}, \right. \\ & \sum_d \left\{ \frac{(\sigma_s - 1)^{\sigma_s - 1}}{\sigma_s^{\sigma_s}} \frac{E_{d,s}}{(P_{d,s})^{1-\sigma_s}} \left(\frac{w_{o,s} \tau_{od,s}}{\varphi} \right)^{1-\sigma_s} \right\} - w_{o,s} f_{o,\tilde{d},s}^x - w_{o,s} f_{o,s}, \\ & \left. \sum_d \left\{ \frac{(\sigma_s - 1)^{\sigma_s - 1}}{\sigma_s^{\sigma_s}} \frac{E_{d,s}}{(P_{d,s})^{1-\sigma_s}} \left(\frac{w_{o,s} \tau_{od,s}}{\xi_{o,s} \varphi} \right)^{1-\sigma_s} \right\} - w_{o,s} f_{o,\tilde{d},s}^x - w_{o,s} \eta_{o,s} f_{o,s} \right\} \end{aligned}$$

Optimization

- Solution involves solving for vector of price indices for energy in each city
- We can characterize solution in terms of three productivity cut-offs
 - Least productive firms exit
 - Next most productive firms sell only in China and do not innovate
 - Next most productive firms also export
 - Highest productivity firms export and innovate

Productivity thresholds determine regimes (optimal profits, π)

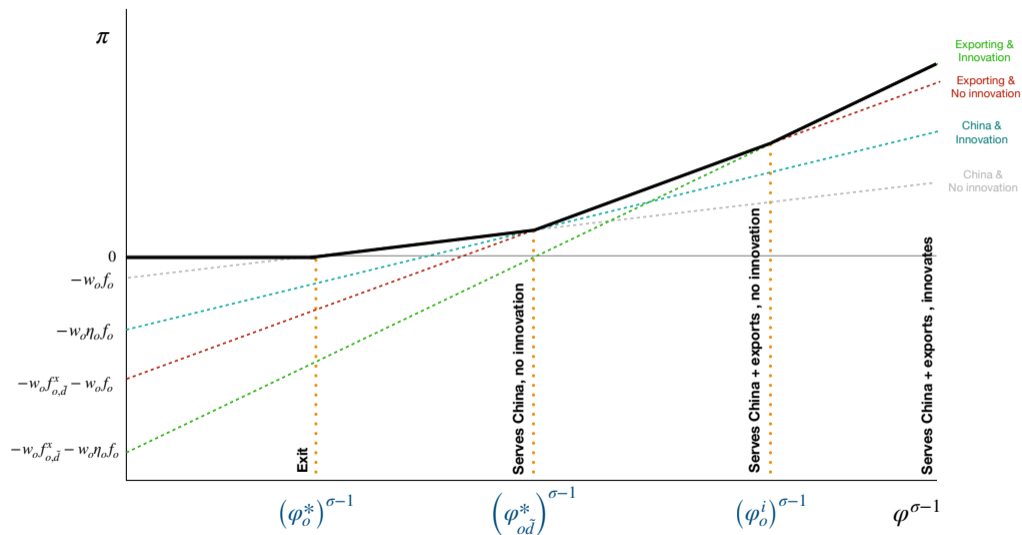

Solar industrial policy

1 Production subsidies

- We model production subsidies $s_{o,s}$ as a reduction in input costs in city o , manufacturers, marginal cost becomes $\frac{1-s_{o,s}}{\varphi}$.

2 Innovation subsidies

- We model innovation subsidies ($\phi_{o,s} < 1$) in city o as a reduction in fixed costs of technological upgrading, which becomes $\phi_{o,s}(\eta_{o,s}f_{o,s})$

3 Demand/Installation subsidies

- We model solar demand subsidies in d as θ_d , shifting $e_d = \left(\kappa_{d,s'} e_{d,s'}^\rho + \theta_d \kappa_{d,s} e_{d,s}^\rho \right)^{1/\rho}$

Theoretical predictions

Figure: Place-based demand subsidies

	<i>Demand Subsidy θ_o</i>	
Innovation _{<i>o</i>}	$\approx +$	
Firm count _{<i>o</i>}	$\approx +$	
Panel production _{<i>o</i>}	$\approx +$	
Revenue _{<i>o</i>}	$\approx +$	
Exports _{<i>o</i>}	$\approx +$	

Notes: All outcome variables and subsidy policies are referred to the same region o . The table shows no prediction on how policies in region d affect outcomes in region o . A ‘prediction’ in this table represents the sign and magnitude of a potential treatment effect for each type of policy and outcome variable. That is, we are predicting the relative difference between treated and untreated regions. The last column corresponds to the type of innovation subsidies that we observe in the data, which are always implemented together with some policy support towards production. $\approx +$ indicates that we expect effects to be plausibly positive but there is some ambiguity in their sign. We rank unambiguously positive effects to provide qualitative intuition on the effectiveness of different policies on improving each outcome. The ranking, from higher to lower effects, is: $+++ > ++ > +$.

Theoretical predictions

Figure: Place-based production subsidies

	<i>Production Subsidy s_o</i>	
Innovation _{<i>o</i>}	+	
Firm count _{<i>o</i>}	++	
Panel production _{<i>o</i>}	++	
Revenue _{<i>o</i>}	++	
Exports _{<i>o</i>}	++	

Notes: All outcome variables and subsidy policies are referred to the same region o . The table shows no prediction on how policies in region d affect outcomes in region o . A ‘prediction’ in this table represents the sign and magnitude of a potential treatment effect for each type of policy and outcome variable. That is, we are predicting the relative difference between treated and untreated regions. The last column corresponds to the type of innovation subsidies that we observe in the data, which are always implemented together with some policy support towards production. $\approx +$ indicates that we expect effects to be plausibly positive but there is some ambiguity in their sign. We rank unambiguously positive effects to provide qualitative intuition on the effectiveness of different policies on improving each outcome. The ranking, from higher to lower effects, is: $+++ > ++ > +$.

Theoretical predictions

Figure: Place-based innovation subsidies

	<i>Innovation Subsidy ϕ_o</i>	
Innovation _{<i>o</i>}	++	
Firm count _{<i>o</i>}	+	
Panel production _{<i>o</i>}	+	
Revenue _{<i>o</i>}	+	
Exports _{<i>o</i>}	+	

Notes: All outcome variables and subsidy policies are referred to the same region o . The table shows no prediction on how policies in region d affect outcomes in region o . A ‘prediction’ in this table represents the sign and magnitude of a potential treatment effect for each type of policy and outcome variable. That is, we are predicting the relative difference between treated and untreated regions. The last column corresponds to the type of innovation subsidies that we observe in the data, which are always implemented together with some policy support towards production. $\approx +$ indicates that we expect effects to be plausibly positive but there is some ambiguity in their sign. We rank unambiguously positive effects to provide qualitative intuition on the effectiveness of different policies on improving each outcome. The ranking, from higher to lower effects, is: + + + > ++ > +.

Theoretical predictions

Figure: Predictions to the data

	<i>Demand Subsidy θ_o</i>	<i>Production Subsidy s_o</i>	<i>Innovation Subsidy ϕ_o</i>	<i>Production & Innovation Subsidy $s_o + \phi_o$</i>
Innovation _{<i>o</i>}	$\approx +$	+	++	+++
Firm count _{<i>o</i>}	$\approx +$	++	+	+++
Panel production _{<i>o</i>}	$\approx +$	++	+	+++
Revenue _{<i>o</i>}	$\approx +$	++	+	+++
Exports _{<i>o</i>}	$\approx +$	++	+	+++

Notes: All outcome variables and subsidy policies are referred to the same region o . The table shows no prediction on how policies in region d affect outcomes in region o . A ‘prediction’ in this table represents the sign and magnitude of a potential treatment effect for each type of policy and outcome variable. That is, we are predicting the relative difference between treated and untreated regions. The last column corresponds to the type of innovation subsidies that we observe in the data, which are always implemented together with some policy support towards production. $\approx +$ indicates that we expect effects to be plausibly positive but there is some ambiguity in their sign. We rank unambiguously positive effects to provide qualitative intuition on the effectiveness of different policies on improving each outcome. The ranking, from higher to lower effects, is: $+++ > ++ > +$.

Outline

① Introduction

② Background

③ Data

④ Model

⑤ **Empirical Strategy**

⑥ Results

Empirical Strategy

- Effectiveness of solar industrial policy
 - Look at dynamics: persisting benefit in the long-term is key infant industry justification
- Challenges in evaluating industrial policy
 - Allocation of solar industrial subsidies by firm highly non-random
 - So focus on introduction of city level subsidy **policies**
 - These are staggered over time - first ones in 2007 (encouraged by Eleventh Five Year Plan)
 - Although no systematic differences in observables in cities, some mild pre-trends.
- We follow the **synthetic-difference-in-differences (SDID)** methodology (Arkhangelsky et al 2021)

Synthetic-difference-in-differences (SDID)

- Outcomes: revenue, panel production, number of firms, exports, and patents
- Treatments: subsidy policies (demand, production, innovation)
- Variation: Exploit city-level variation in solar policies and their timing
- SDID: Two-way FE regression with time and unit weights

$$\left(\hat{\tau}^{\text{sdid}}, \hat{\mu}, \hat{\alpha}, \hat{\beta} \right) = \underset{\tau, \mu, \alpha, \beta}{\text{arg min}} \left\{ \sum_{i=1}^N \sum_{t=1}^T \left(Y_{it} - \mu - \alpha_i - \beta_t - W_{it} \tau^{\text{sdid}} \right)^2 \hat{\omega}_i^{\text{sdid}} \hat{\lambda}_t^{\text{sdid}} \right\}$$

- Unit weights ω_i : chosen so that average pre-treatment outcome for control units is \approx parallel to pre-treatment outcome for treated units
- Time weights λ_t : more weight on time periods which better predict post-treatment outcomes for control

SDID Intuition

- 1 Construct synthetic control group such that pre-trends are approximately parallel
 - 2 Compute treatment effect using diff-in-diff between treatment and synthetic control
- Allows us to relax the parallel trends assumption
 - Comparison with TWFE
 - SDID as a generalization of TWFE that allows for weighting the control group to construct a better counterfactual
 - We use cohort-by-cohort estimation approach, with never treated as control group
 - We aggregate all these cohort estimates to obtain one aggregate ATT for each type of policy

Outline

- 1 Introduction
- 2 Background
- 3 Data
- 4 Model
- 5 Empirical Strategy
- 6 Results**

Results: Patents

Figure: Patent Counts (Example of 2007 Cohort)

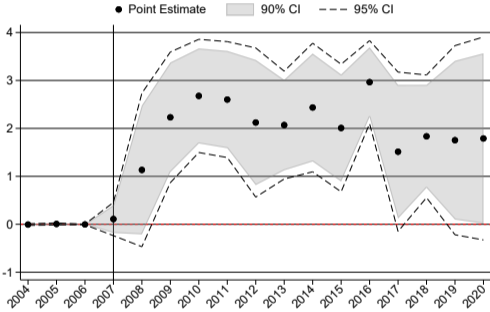
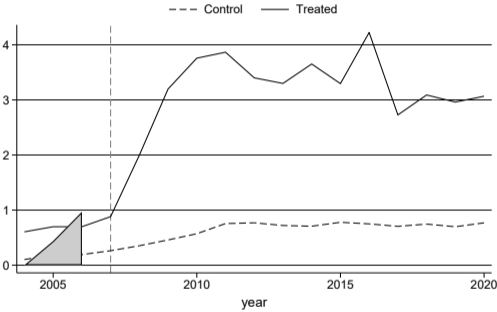

Notes: SDID on 358 cities, 3 (Jonzhou, Xinju & Yangzhou) introduced policy in 2007. Outcome: IHS of patents by solar firms in a city-year. SE cluster bootstrapped by city.

2013 raw

Results: Patents

Table: Patent Counts (Aggregate ATT)

	<i>Any subsidy</i>	<i>Demand subsidy</i>	<i>Production subsidy</i>	<i>Innovation subsidy</i>
All patents	0.496** (0.200)	0.236 (0.275)	0.871*** (0.227)	1.060*** (0.367)
Observations	6,086	6,086	6,086	6,086

Notes: * 0.1 ** 0.05 *** 0.01. SDID on 358 cities 2004-2020. Outcome is IHS of patent count by solar firms in a city-year pair (av. = 13.1). SE cluster bootstrapped by city.

Levels

Results: Quality-adjusted Patents I (Citation-weighted)

Table: Patent Citations (Aggregate ATT)

	<i>Any subsidy</i>	<i>Demand subsidy</i>	<i>Production subsidy</i>	<i>Innovation subsidy</i>
Patent citations	0.676*** (0.218)	0.388 (0.328)	0.854*** (0.300)	1.076** (0.482)
Observations	6,086	6,086	6,086	6,086

Notes: *0.1 ** 0.05 *** 0.01. SDID on 358 cities 2004-2020. Outcome is IHS of patent count (weighted by future citations) by solar firms in a city-year pair. SE cluster bootstrapped by city.

Results: Quality-adjusted Patents II (patent type)

Table: Invention vs. design Patents (Aggregate ATT)

	<i>Any subsidy</i>	<i>Demand subsidy</i>	<i>Production subsidy</i>	<i>Innovation subsidy</i>
All patents	0.496** (0.200)	0.236 (0.275)	0.871*** (0.227)	1.060*** (0.367)
<input type="checkbox"/> Design patents	0.186 (0.138)	0.277 (0.216)	0.237 (0.173)	0.151 (0.253)
<input type="checkbox"/> invention/utility model patents	0.529*** (0.201)	0.201 (0.274)	0.937*** (0.232)	1.097** (0.373)

Notes: * 0.1 ** 0.05 *** 0.01. SDID on 358 cities 2004-2020. Outcome is IHS of patent count.

Classifying Patents as LBD/process innovation

- Liu (2023) classifies random sample of 3,299 Chinese solar patents into whether they are productivity improving (vs. product innovation) based on text [Example patents](#)
- Use this as a training dataset to classify all our patents into these process innovations (so closer to LBD) using random forest algorithm
- Cross validate using 15% hold-out sample and find high (90%+) accuracy
- Using counts of this sub-sample as an outcome

Results: LBD Patents

Table: Learning-by-doing Patents (Aggregate ATT)

	<i>Any subsidy</i>	<i>Demand subsidy</i>	<i>Production subsidy</i>	<i>Innovation subsidy</i>
Patent	0.365** (0.149)	0.187 (0.186)	0.604*** (0.235)	0.914*** (0.377)
Observations	5,728	5,728	5,728	5,728

Notes: * 0.1 ** 0.05 *** 0.01. 358 cities with 43 treated. 2004-20. Outcome is IHS of "LBD" patents count

Results: Revenue (quicker & larger effects than patents)

Figure: Revenue (2007 Cohort)

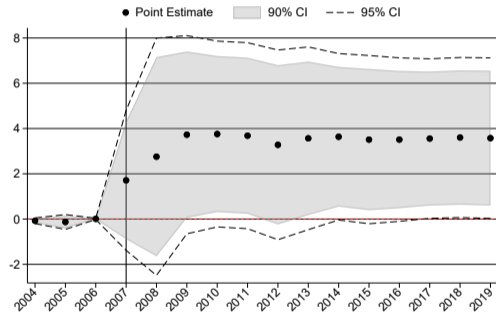
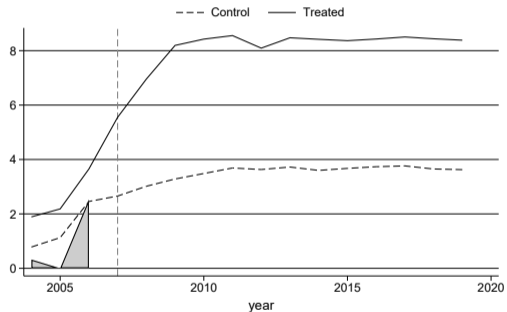

Notes: SDID estimates on 358 cities, focusing on the 3 that introduced a policy in 2007. Outcome is IHS of revenue of solar firms in a city-year pair.

Results: Revenue

Table: Revenue (Aggregate ATT)

	<i>Any subsidy</i>	<i>Demand subsidy</i>	<i>Production subsidy</i>	<i>Innovation subsidy</i>
Revenue	1.100** (0.456)	0.192 (0.199)	1.887** (0.767)	2.670** (1.193)
Observations	5,728	5,728	5,728	5,728

Notes: * 0.1 ** 0.05 *** 0.01. SDID estimates on 358 cities 2004-2019. Outcome is IHS of revenue of solar firms in a city-year pair.

Levels

Results: Production Capacity

Figure: Panel Production Capacity (2007 Cohort)

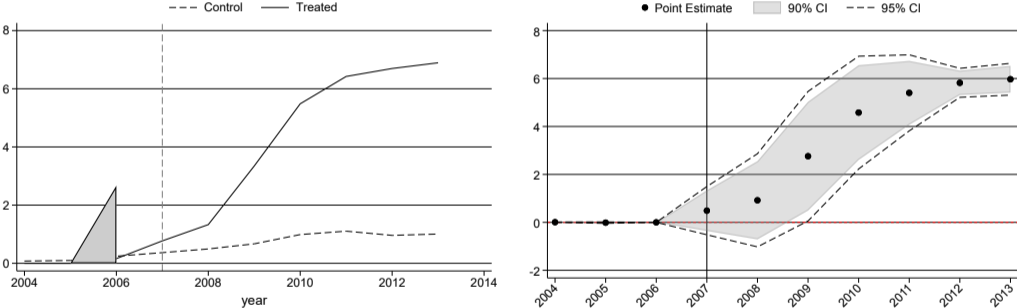

Notes: SDID estimates on 358 cities, focusing on the 3 that introduced a policy in 2007. Outcome is IHS of Solar Panel production capacity in a city-year pair.

Results: Production Capacity

Table: Solar Panel Production Capacity (Aggregate ATT)

	<i>Any subsidy</i>	<i>Demand subsidy</i>	<i>Production subsidy</i>	<i>Innovation subsidy</i>
Panel production	2.098*** (0.532)	0.587 (0.467)	2.496*** (0.575)	2.930*** (0.773)
Observations	3,580	3,580	3,580	3,580

Notes: * 0.1 ** 0.05 *** 0.01. SDID estimates on 358 cities 2004-2019. Outcome is IHS of production capacity of solar firms in a city-year pair.

Results: Firm Count

Figure: Firm Count - Number of Solar Firms (2007 Cohort)

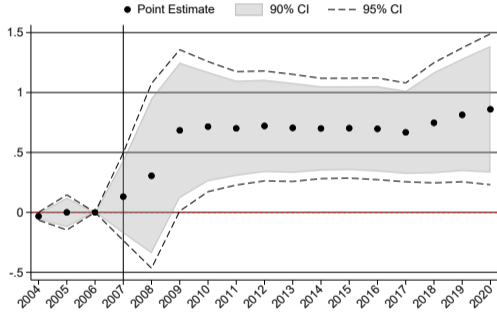
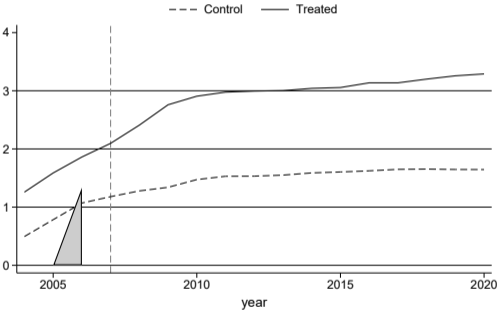

Notes: SDID estimates on 358 cities, focusing on the 3 that introduced a policy in 2007. Outcome is IHS of number of solar firms in a city-year pair.

Results: Firm Count

Table: Firm Count - Number of Solar Firms (Aggregate ATT)

	<i>Any subsidy</i>	<i>Demand subsidy</i>	<i>Production subsidy</i>	<i>Innovation subsidy</i>
Firm count	0.186*** (0.064)	0.060 (0.043)	0.288*** (0.090)	0.381*** (0.135)
Observations	6,086	6,086	6,086	6,086

Notes: * 0.1 ** 0.05 *** 0.01. SDID estimates on 358 cities 2004-2020. Outcome is IHS of count of solar firms in a city-year pair.

Results: Exports

Figure: Export Value (2007 Cohort)

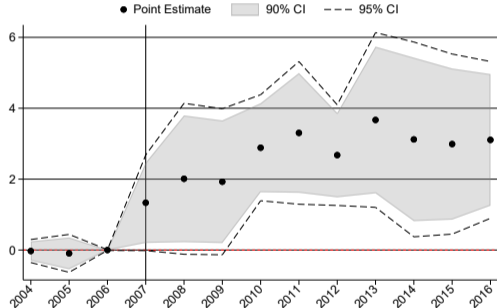
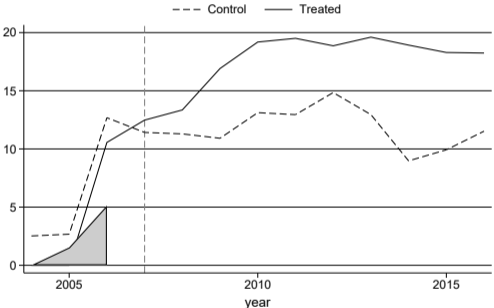

Notes: SDID estimates on 358 cities, focusing on the 3 that introduced a policy in 2007. Outcome is IHS of export value of Solar firms in a city-year pair.

Results: Exports

Table: Exports (Aggregate ATT)

	(1) <i>Any subsidy</i>	(2) <i>Demand subsidy</i>	(3) <i>Production subsidy</i>	(4) <i>Innovation subsidy</i>
Export value	2.451** (1.178)	0.658 (1.130)	3.217** (1.443)	4.160** (2.143)
Solar export value	4.688*** (1.302)	1.443 (0.918)	6.464*** (1.734)	9.360*** (2.230)
Observations	4,654	4,654	4,654	4,654

Notes: * 0.1 ** 0.05 *** 0.01. Solar exports classified via HS8. SDID on 358 cities 2004-2016. Outcome is IHS.

Extensions & Robustness

- Business stealing vs. agglomeration business stealing results
- Productivity productivity results
- City-level total solar patents city-level patents
- Adding controls to SDID (GDP, population, income, tax revenue, ...) results with controls
- Placebos on GDP, non-solar patents, etc.
- Results in levels, etc. (Chen and Roth, 2022) results in levels
- Magnitudes and Cost-Benefit

Mean subsidy for solar firms in treated vs. control cities (RMB13m per city after 2009

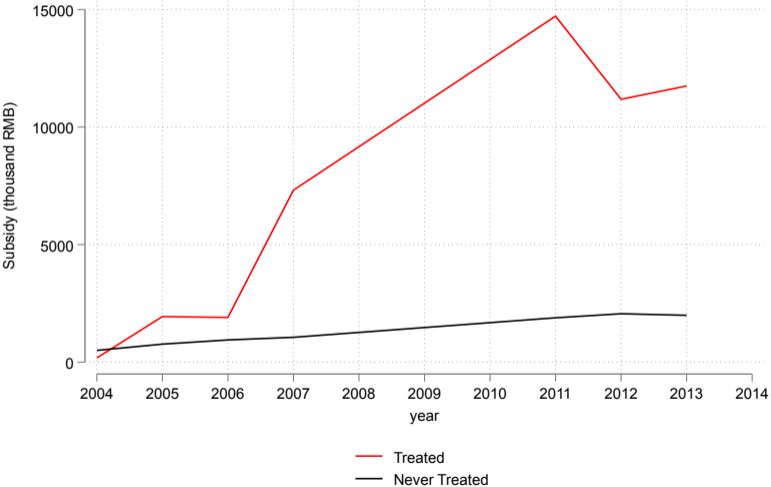

SDID analysis of impact on ASIE subsidies of introduction of policy

Table: Subsidy value (level)

	(1)	(2)	(3)	(4)
	<i>Any subsidy</i>	<i>Demand subsidy</i>	<i>Production subsidy</i>	<i>Innovation subsidy</i>
Subsidy value (million RMB)	13.601* (7.693)	-0.527 (1.293)	15.993* (9.276)	24.177 (17.621)
Observations	2,457	2,457	2,457	2,457
Mean of Dep. var.	1.492	1.492	1.492	1.492

→ These are: US\$1.9 million for any subsidy, US\$2.2 m for production subsidy, US\$3.4 m for innovation subsidy.

Back of Envelope Cost-Benefit

- Consider steady state and abstract from GE effects. (split sample IV effect of subsidy)
- Using mean observed cost or estimated ATT marginal cost of subsidy + admin costs + 40% deadweight cost of taxation = US \$3m p.a. per policy
- Revenue benefits ten times higher.
- Removing all subsidy policies would reduce aggregate Chinese solar patent flow by about a quarter a year
- Caveat: Might be missing hidden costs such as other subsidies and distortions (e.g. Kalouptsidi (2018); Barwick, Kalouptsidi and Zahur (2021)) InnoCom

Conclusions and next steps

- New and comprehensive database on the Chinese solar industry and local solar industrial policy
- China's local solar production and innovation subsidies are effective at stimulating local solar industry (innovation, firm numbers, revenue, production, exports)
- Initial assessment of the cost of the policies points towards positive returns
- Theoretical model's initial predictions consistent with empirical analysis
- Next steps: model quantification and counterfactual analysis. Consider international version to look at global effects

Citations

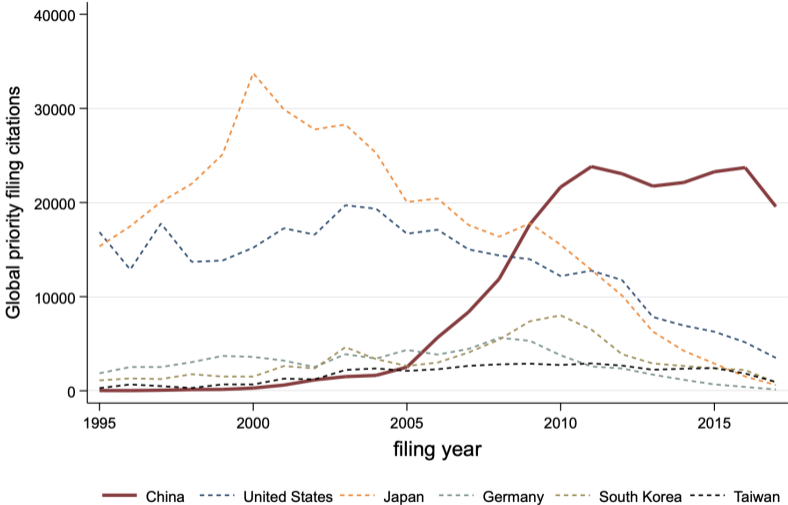

[Back](#)

Triadic patents

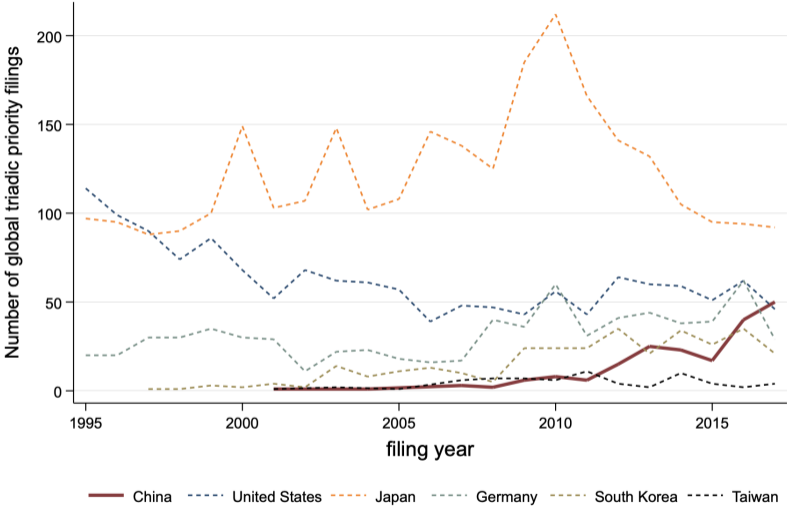

Back

Company Name	Region	No. Staff	No. of Known Sellers	Power Range(Wp)
1st Sunergy	United States			175-290
2ES	France	15		135-150
2Power	Germany	50	1	215-325
3D Energy	Italy	20		200-450
3G-Solar	Germany			155-300
3Hz Solar	China			140-540
3KM Power	China			410
3S	China	300	1	40-600
3S Swiss Solar Solutions	Switzerland		1	115-200
5Star Solar	China		1	240-370
8.33 Solar	Spain		5	270-345
A. D. Global Synergies	India			3-300
A.R.E.	Egypt			325-340
Abba	Italy			230-300
Abcw Power	China			5-350
ABI-Solar	United States		18	275-470
Abotree Solar	China			0.3-360
Abshine	China	100		255-270
Arness Solar	India		1	2-220

Back

Featured Product (Solar Panels)



XL120H-360-380W

XLA Solar

From E0.104 / Wp

Cell Type: Monocrystalline
 Dimensions: 1755x1038x35 mm
 Weight: 19.5 kg
 Cell Size: 166x166 mm
 Glass Thickness: --

More

Featured Product (Solar Panels)



GSM-MP3/132-BM...

Grand Sunergy

Cell Type: Bifacial, PERC
 Dimensions: 2384x1303x35 mm
 Weight: 38.5 kg
 Cell Size: --
 Glass Thickness: --

More



Monocrystalline -- Solar Panel Manufacturers

Companies involved in monocrystalline panel production. 1,446 monocrystalline panel manufacturers are listed below.

[Solar Panels](#) / [Crystalline](#) / [Monocrystalline](#)

Ad	Company Name	Region	No. Staff	No. of Known Sellers	Power Range(Wp)
	Horay Solar	China	400	2	50-660
	Grand Sunergy	China			
	Mysolar USA	United States			

Company Name	Region	No. Staff	No. of Known Sellers	Power Range(Wp)
1st Sunergy	United States			170-200

[Back](#)

Featured Product (Solar Panels)



XL120H-360-380W
XLA Solar

From £0.104 / Wp

Cell Type: Monocrystalline
 Dimensions: 1755x1038x35 mm
 Weight: 19.5 kg
 Cell Size: 166*166 mm
 Glass Thickness: --

[More](#)

Featured Product (Solar Panels)



GSM-MP3/132-BM...
Grand Sunergy

Cell Type: Bifacial, PERC
 Dimensions: 2384x1303x35 mm
 Weight: 38.5 kg
 Cell Size: --
 Glass Thickness: --



Guangzhou 3Hz Solar Technology Co., Ltd.



Building C5, Huachuang Industrial Park, Shiji Town, Panyu District, Guangzhou, Guangdong, 511430

+86 20 34784859

fang@3hz-solar.com

www.3hz-solar.com

China



Staff Information

Useful Contacts



Fang
总经理



Jack
Sales



陈芳
采购

Company Description Ad



Guangzhou 3Hz Solar Technology Co., Ltd. is a private and new high tech enterprise which specializes at solar photovoltaic and wind-solar hybrid products' R&D, manufacturing and sales. We mainly engage in the researching, manufacturing, sales and after-sales service of the products such as home solar battery, photovoltaic system engineering, solar energy application, wind-solar hybrid application. Since its foundation, our company has devoted the mind to business development and continuous product innovation, drawn large-scale automated production line and set up a professional R&D technology center. We have powerful technical resources, sophisticated equipment and advanced production technology, would like to propose all-around solution of solar and wind-solar hybrid systems integration for customers, promote the popularization and application of solar energy. Our products has passed certificates such as CE and ROHS, and a number of them have obtained national patents.

Panels

Components

Business Details

Monocrystalline Polycrystalline

Back

Featured Product (Solar Panels)



Aurora TOPCon 182 RS41...

Runda Solar

From £0.147 / Wp

Cell Type:	TOPCon
Dimensions:	1722x1134x30 mm
Weight:	21 kg
Cell Size:	--
Glass Thickness:	--

More

Featured Product (Solar Panels)



N-Type 5F-M18/144 topcon

Shinefar Solar

From £0.169 / Wp

Cell Type:	Monocrystalline
Dimensions:	2278x1134x35 mm
Weight:	28 kg
Cell Size:	182x182 mm
Glass Thickness:	3.2 mm

More

Spatial concentration of the Chinese solar industry

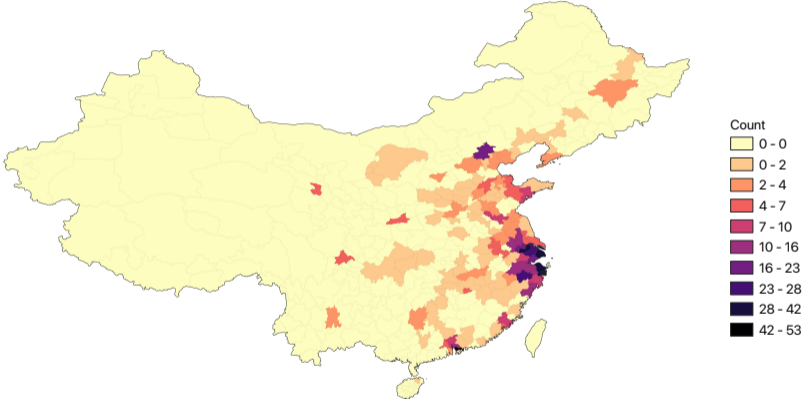

Note: Number of solar firms in different Chinese cities, 2019 [Back](#)

Spatial concentration of the Chinese solar industry



Solar PV in the Chinese government's Five-Year Plans

- **2001-2005 Tenth Five-Year Plan:**

- Solar a targeted sector for first time, together with other renewable energies.
- In 2001 no solar industry.
- In 2005 considerable growth.

- **2006-2010 Eleventh Five-Year Plan:**

- Solar industry as an opportunity to attain technological leadership.
- Included funding for R&D and manufacturing development for the first time.
- Solar industry witnessed exceptional growth

- **2011-2015 Twelfth Five-Year Plan:**

- Government kept pushing for solar adoption, supply-chain expansion and indigenous R&D.
- R&D goals gained in detail and scope

- **2016-2020 Thirteenth Five-Year Plan:**

- Targeting capacity and R&D expansion, as well as industry-wide cost-reduction.
- Includes Thirteenth Five Year Plan for Solar Energy Development.

Back

Renewable electricity capacity, especially solar, has grown rapidly

Figure: World electricity generation by source

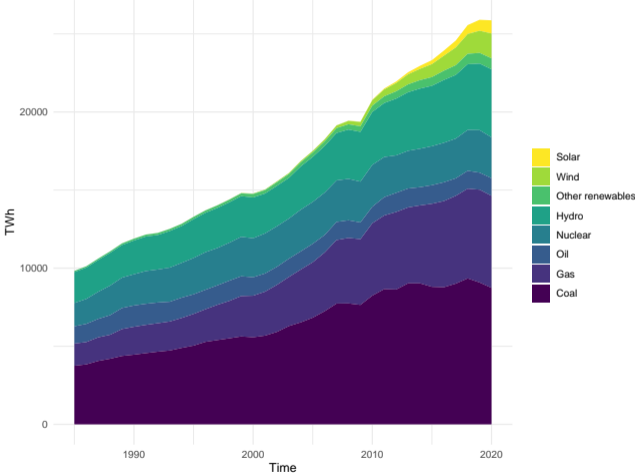

Source: International Energy Agency (IEA) [Back](#)

The productivity thresholds in the data

Figure: Number of firms (ASIE) in each group

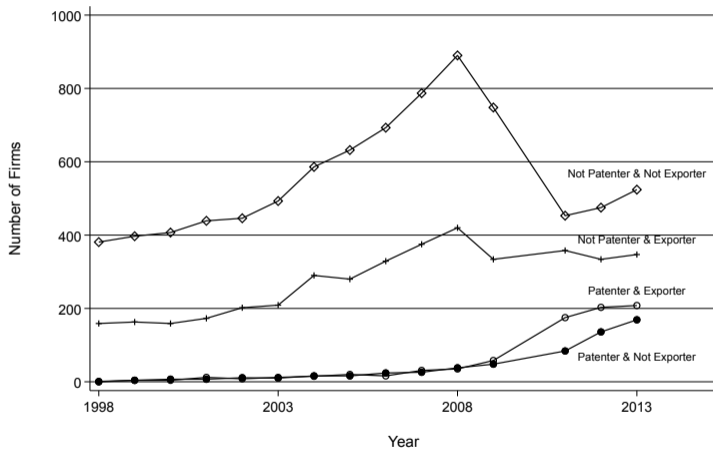

Note: Firm-level data from ASIE, merged with SIPO.

LBD-Patent: Patent as process innovation

Grid Line Structure for Solar Cell manufacturing (CN104752533A)

This invention comprises metal wires and conductive silver paste. The grid line is woven from metal wires, with a layer of silver paste applied to the metal wires which ensures excellent adhesion between the silver paste and the metal wires as well as strong ohmic contact between the sub-grid line and the silicon wafer. The silver paste used for the main grid line does not contain glass material, which ensures good adhesion between the main grid line and the silicon wafer and reduces the recombination of minority carriers under the main grid line.

Compared with the prior art, the present invention greatly reduces the amount of (expensive) silver paste used generating big cuts in production costs. It ensures excellent aspect ratios of the grid lines, eliminating the possibility of broken lines and false prints, thereby improving the photovoltaic conversion efficiency of the solar cell, and being suitable for large-scale industrial production.

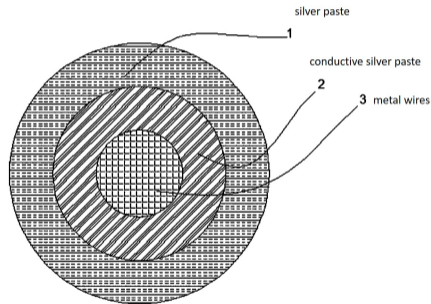

[Back to Data Section](#)

[Back to Results Section](#)

LBD-Patent: Patent as process innovation

Transfer Assembly of a Solar Cell (CN208706675U)

The utility model discloses a transfer assembly of a solar cell piece with a metal-stacked electrode. The assembly comprises a trolley body, a storage member arranged on the top of the trolley body, and a positioning component arranged on the storage member. A plurality of slots are opened on the storage member, and a storage plate is slidably connected in each slot. The top of the storage plate is provided with a groove, a spring is provided on the inner wall of each slot, the spring is connected to the storage plate, a first connecting hole is opened on the storage plate, and a second connecting hole penetrating all the slots is opened on the storage member. The positioning component includes a support column, a crossbar, a pulley, a rope, a motor, a limit rod, and a sliding block. **The utility model delivers the solar cell piece through the newly designed transfer assembly. The structure is simple, easy to install and transport, and will not damage the solar cell piece during transportation, reducing the defect rate and ensuring product quality.**

[Back to Data Section](#)

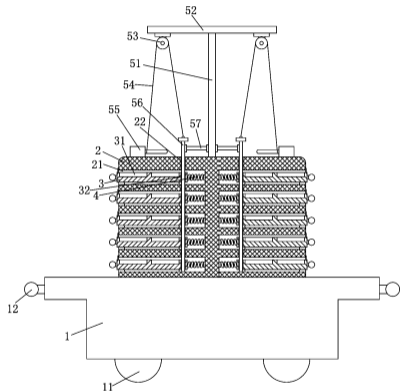

Non-LBD Patent

Road Cliff Lighting Device (CN212273899U)

This utility model patent relates to a road cliff photovoltaic lighting device, which includes a road cliff stone or road guardrail connected to the outer surface of a photovoltaic component. The photovoltaic component is connected to the inverter and battery through a controller in sequence, and the controller is connected to the light strip. The light strip is located on one side of the road cliff stone or road guardrail facing the center of the road. By combining the photovoltaic power generation system with the road cliff or guardrail lighting, photovoltaic power generation, which serves as green energy, is closely integrated with transportation, solving the power supply and subsequent maintenance problems of traditional road lighting and reducing construction and maintenance costs. It also produces an uninterrupted power supply to indicate the road dividing lines and boundary lines, guiding the passage of vehicles and pedestrians, relieving driving fatigue and beautifying the road.

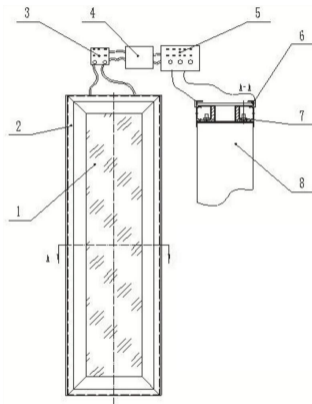

[Back to Data Section](#)

Non-LBD Patent

New Phosphide Material

The present invention provides a carbon-doped P-type gallium phosphide material, in which carbon is used as the doping element of the P-type gallium phosphide semiconductor material. The preparation method of the material is to use metal organic chemical vapor deposition technology, introduce organic gallium source and phosphorus source into the reaction chamber, let them decompose at high temperature, and react on the surface of the substrate to produce gallium phosphide material. During the generation of gallium phosphide material, carbon impurities are introduced by inputting substances containing carbon elements, or by utilising carbon atoms generated by the organic gallium source during thermal decomposition. In the present invention, carbon replaces Mg or Zn. Since carbon doping has a small diffusion coefficient and stable properties, highly doped GaP materials can be produced, which are characterised by high efficiency, low diffusion, and high stability.

[Back to Data Section](#)

Descriptive Statistics

	Mean	Std. Dev.	Sample Size
SIPO, 2004-2020, 358 cities:			
Total patents by solar firms	13.1	111.3	6,086
Design patents	1.2	10.4	6,086
Utility model and invention patents	11.9	102.8	6,086
Orbis and Qichacha, 358 cities:			
Total number of solar firms, 2004-2020	2.9	10.2	6,086
Total revenue of solar firms, RMB, billions, 2004-2019	0.304	1.15	5,728
Customs, 358 cities:			
Total export value of solar firms, millions USD, 2004-2016	24.8	186	4,654
Total export volume of solar firms, millions, 2004-2015	3.18	43.7	4,296
Average export price of solar firms, USD, 2004-2015	9,716	480,762	4,296

Notes: Each observation is city-year pair. There are up to 358 cities between 2004 and 2020 (6,086 observations), but different datasets may have lower numbers of observations as noted in the table.

[Back to Data Section](#)

Descriptive Statistics

	Mean	Std. Dev.	Sample Size
ENF, 2004-2013, 358 cities:			
Total Solar Panel capacity, MWh	82.4	483.3	3,580
Total Solar Panel production, MWh	40.7	265.5	3,580
Total Solar Cell capacity, MWh	50.8	353.4	3,580
Total Solar Cell production, MWh	31.3	233.0	3,580
Total Number of Solar Panel firms	0.9	3.5	3,580
Total Number of Solar Cell firms	0.2	1.0	3,580
Statistics Yearbook, 2004-2020, 284 cities:			
GDP, billion RMB	196.0	307.2	4,828
Population, thousand	4,453	3,176	4,828
GDP per capita, RMB	43,497	46,936	4,828

Notes: Each observation is city-year pair. There are up to 358 cities between 2004 and 2020 (6,086 observations), but different datasets may have lower numbers of observations as noted in the table.

[Back to Data Section](#)

Validation with ASIE

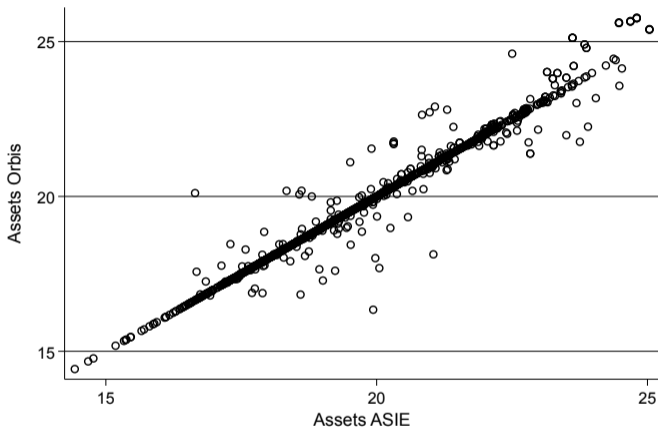

Notes: The axis is the $\log(\text{assets})$ in the ASIE data set, and the y-axis is the $\log(\text{assets})$ in the Orbis data set. Each point is one firm in one year. If we fit a linear line, the coefficient is 1.01, $p < 0.01$, and $R^2 = 0.9679$

Results 2013 Cohort

Figure: Patent (2013 Cohort)

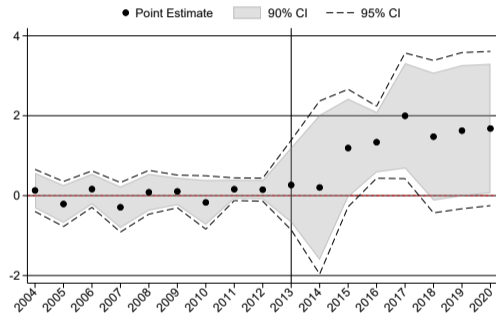
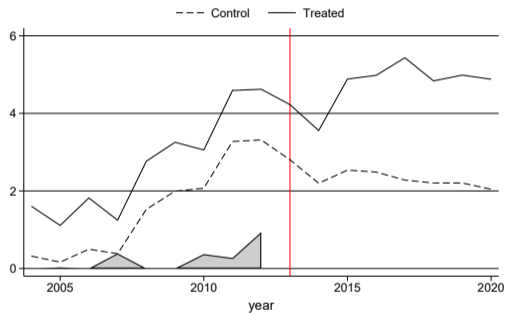

Notes: SDID estimates on 358 cities, focusing on the 3 that introduced a policy in 2013. Outcome IHS of patents by solar firms in a city-year. SE cluster bootstrapped by city.

Back

Results 2013 Cohort

Figure: Revenue (2013 Cohort)

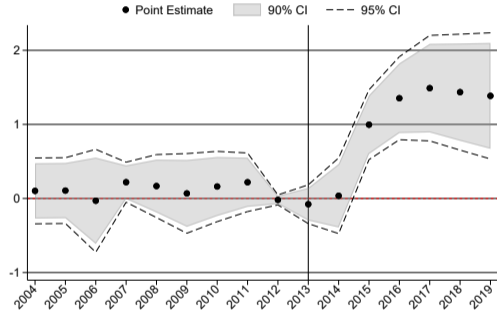
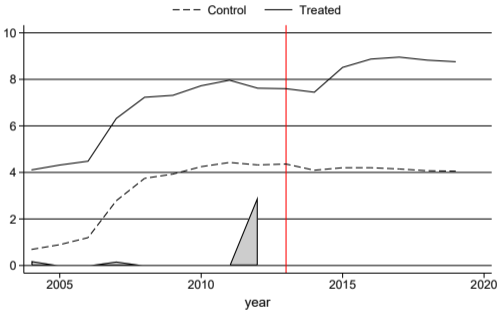

Notes: SDID estimates on 358 cities, focusing on the 3 that introduced a policy in 2013. Outcome is IHS of revenue of solar firms in a city-year pair. SE cluster bootstrapped by city.

[Back](#)

Figure: Number of patents by solar firms for the treated and control group in 2007

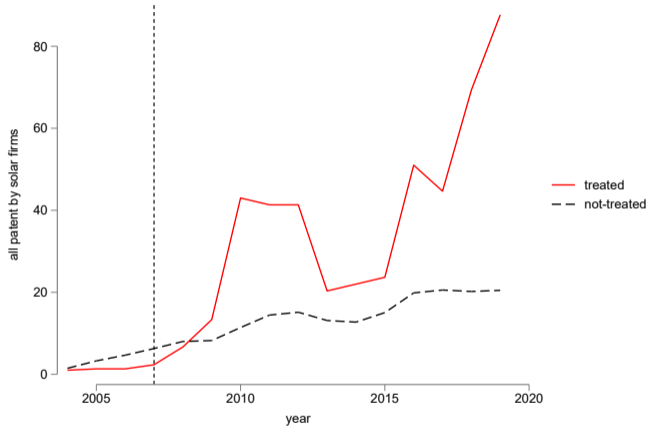

Back

Figure: Number of patents by solar firms for the three cities treated in 2007

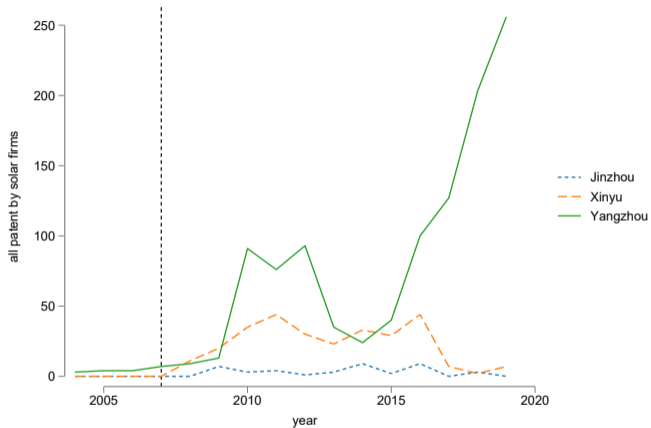

Back

Figure: Total revenue by solar firms for the treated and control group in 2007

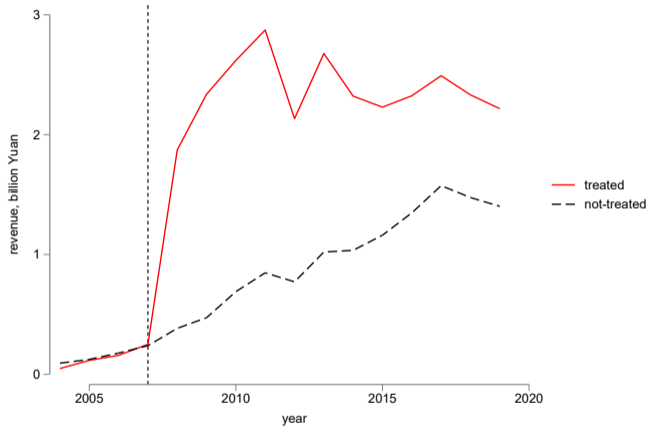

Back

Figure: Total revenue by solar firms for the three cities treated in 2007



Back

Results

Table: Productivity (Aggregate ATT)

Panel A	(1)	(2)	(3)	(4)
Period: 2004-2019	<i>Any subsidy</i>	<i>Demand subsidy</i>	<i>Production subsidy</i>	<i>Innovation subsidy</i>
Revenue	1.100** (0.456)	0.190 (0.198)	1.887** (0.767)	2.670** (1.193)
Labor	0.859** (0.435)	0.249 (0.291)	1.443** (0.664)	1.832* (1.034)
Capital	0.609 (0.408)	-0.130 (0.198)	1.302* (0.767)	1.858 (1.193)
Observations	5,728	5,728	5,728	5,728

Notes: * 0.1 ** 0.05 *** 0.01.

Back

Results

Table: Productivity (Aggregate ATT) cont.

Panel B	(1)	(2)	(3)	(4)
Period: 2004-2013	<i>Any subsidy</i>	<i>Demand subsidy</i>	<i>Production subsidy</i>	<i>Innovation subsidy</i>
Revenue	1.926** (0.767)	0.285 (0.193)	2.392** (0.944)	3.058** (1.517)
Panel production capacity	2.098*** (0.532)	0.587 (0.467)	2.496*** (0.575)	2.930*** (0.773)
Labor	1.382** (0.677)	0.523 (0.442)	1.581* (0.848)	1.773 (1.188)
Capital	1.470** (0.711)	0.310 (0.282)	1.784** (0.905)	2.307 (1.426)
Observations	3,580	3,580	3,580	3,580

Notes: * 0.1 ** 0.05 *** 0.01.

Back

Results

Table: Positive Spillovers outweighs Business Stealing (cf. Bloom, Schankerman & Van Reenen, 2013)

	(1)	(2)	(3)	(4)	(5)
	All patents	Firm count	Revenue	Panel capacity	Export value
Any subsidy in an adjacent city	0.373*** (0.096)	0.099 (0.055)	0.485*** (0.177)	0.385 (0.263)	0.659 (0.432)
Observations	5,049	5,049	4,768	3,210	3,861

Back

Spillover discussion

- Cross-city spillovers positive, but smaller coefficients than own-effects. Also true for other policies.

Spillover discussion

- Cross-city spillovers positive, but smaller coefficients than own-effects. Also true for other policies.
- Might expect this from demand policies, but supply policies expected to have negative effects through business stealing

Spillover discussion

- Cross-city spillovers positive, but smaller coefficients than own-effects. Also true for other policies.
- Might expect this from demand policies, but supply policies expected to have negative effects through business stealing
- Suggestive of positive cross-city technological spillovers that outweigh business stealing (see Bloom, Schankerman and Van Reenen, 2013).

Spillover discussion

- Cross-city spillovers positive, but smaller coefficients than own-effects. Also true for other policies.
- Might expect this from demand policies, but supply policies expected to have negative effects through business stealing
- Suggestive of positive cross-city technological spillovers that outweigh business stealing (see Bloom, Schankerman and Van Reenen, 2013).
- Investigating using patent citation patterns and alternative distance metrics.

Back

Other policies: Innocom

- Wei et al. (2023) and Chen et al. (2021) examine Innocom, a major policy which after 2008 increased incentives for patenting and R&D through lower tax
- Had many features which led to low quality patents and relabeling of expenses
- But unlikely that this correlated with solar policies (a time effect). Placebo on non-solar patents show zero effects
- Wei et al. (2023) show many purchases of patents to hit six patents used by bureaucrats as indicator
- We only use first filing. Also examine through dropping firms with a spike at 6 patents.

Back

Results

Table: Controlling for GDP per capita

	(1)	(2)	(3)	(4)
	<i>Any subsidy</i>	<i>Demand subsidy</i>	<i>Production subsidy</i>	<i>Innovation subsidy</i>
All patent	0.483** (0.205)	0.226 (0.242)	0.867*** (0.220)	1.001*** (0.341)
□ Design patents	0.187 (0.132)	0.275 (0.190)	0.240 (0.167)	0.141 (0.254)
□ Invention/utility model patents	0.527** (0.213)	0.191 (0.241)	0.960*** (0.232)	1.051*** (0.361)
● Solar patents	0.523*** (0.191)	0.247 (0.230)	0.802*** (0.204)	0.875*** (0.339)
● Non-solar patents	0.254 (0.182)	-0.061 (0.215)	0.739*** (0.217)	0.801** (0.349)
Firm count	0.210*** (0.081)	0.030 (0.031)	0.380*** (0.125)	0.396*** (0.138)
Revenue	1.076** (0.458)	0.170 (0.205)	1.882*** (0.727)	2.557*** (1.102)

Notes: * 0.1 ** 0.05 *** 0.01.

Back

Results

Table: Controlling for GDP per capita (cont.)

	(1)	(2)	(3)	(4)
	<i>Any subsidy</i>	<i>Demand subsidy</i>	<i>Production subsidy</i>	<i>Innovation subsidy</i>
Panel capacity	2.025*** (0.466)	0.531 (0.428)	2.415*** (0.470)	2.848*** (0.705)
Export value	2.409*** (0.886)	0.577 (1.009)	3.210** (1.292)	4.041** (1.992)
Export volume	2.066** (0.812)	0.038 (0.699)	2.841** (1.208)	3.726** (1.851)
Export price	0.925** (0.407)	0.176 (0.483)	1.078** (0.534)	1.354 (0.896)
Solar export value	4.515*** (0.970)	1.367* (0.741)	6.250*** (1.428)	8.967*** (2.136)
Solar export volume	3.848*** (0.864)	0.905 (0.688)	5.120*** (1.251)	7.231*** (1.803)
Solar export price	1.485*** (0.422)	0.134 (0.379)	2.001*** (0.665)	3.186*** (0.833)

Notes: * 0.1 ** 0.05 *** 0.01.

Back

Results

Table: Levels results (Patents)

	(1)	(2)	(3)	(4)
	<i>Any subsidy</i>	<i>Demand subsidy</i>	<i>Production subsidy</i>	<i>Innovation subsidy</i>
All patents	6.310 (9.949)	-7.076 (14.578)	20.046** (9.569)	25.613* (14.873)
Observations	6,086	6,086	6,086	6,086
Mean of Dep. var.	13.128	13.128	13.128	13.128

Notes: * 0.1 ** 0.05 *** 0.01.

Back

Results

Table: Levels results (Revenue)

	(1)	(2)	(3)	(4)
	<i>Any subsidy</i>	<i>Demand subsidy</i>	<i>Production subsidy</i>	<i>Innovation subsidy</i>
Revenue (million RMB)	273** (111)	76.5 (96.4)	427** (179)	576* (344)
Observations	5,728	5,728	5,728	5,728
Mean of Dep. var.	304	304	304	304

Notes: * 0.1 ** 0.05 *** 0.01.

[Back to Main Results](#)

[Back to Extensions](#)

Results

Table: Levels results (Panel capacity)

	(1)	(2)	(3)	(4)
	<i>Any subsidy</i>	<i>Demand subsidy</i>	<i>Production subsidy</i>	<i>Innovation subsidy</i>
Panel capacity (MWh)	319.567** (128.377)	138.574 (127.902)	366.728** (147.783)	480.764*** (175.088)
Observations	3,580	3,580	3,580	3,580
Mean of Dep. var.	82.449	82.449	82.449	82.449

Back

Notes: * 0.1 ** 0.05 *** 0.01.

Results

Table: Levels results (Firm count)

	(1) <i>Any subsidy</i>	(2) <i>Demand subsidy</i>	(3) <i>Production subsidy</i>	(4) <i>Innovation subsidy</i>
Firm count	1.199 (0.898)	-0.257 (0.617)	2.505* (1.462)	2.900 (2.122)
Observations	6,086	6,086	6,086	6,086
Mean of Dep. var.	2.872	2.872	2.872	2.872

Back

Notes: * 0.1 ** 0.05 *** 0.01.

Results

Table: Levels results (Exports)

	(1)	(2)	(3)	(4)
	<i>Any subsidy</i>	<i>Demand subsidy</i>	<i>Production subsidy</i>	<i>Innovation subsidy</i>
Export value (million RMB)	51.4** (23.9)	22.8 (31.0)	56.3* (28.8)	85.9** (42.9)
Observations	4,654	4,654	4,654	4,654
Mean of Dep. var.	24.791	24.791	24.791	24.791

Notes: * 0.1 ** 0.05 *** 0.01.

Back

Results

Table: City-level total solar patents

	(1) <i>Any subsidy</i>	(2) <i>Demand subsidy</i>	(3) <i>Production subsidy</i>	(4) <i>Innovation subsidy</i>
Patent	0.444*** (0.150)	0.114 (0.138)	0.662*** (0.213)	1.029*** (0.219)
Observations	6,086	6,086	6,086	6,086

Notes: * 0.1 ** 0.05 *** 0.01.

Back

Results

Table: LEARNING-BY-DOING PATENTS

	(1)	(2)	(3)	(4)
	<i>Any subsidy</i>	<i>Demand subsidy</i>	<i>Production subsidy</i>	<i>Innovation subsidy</i>
Patent	0.365** (0.149)	0.187 (0.186)	0.604*** (0.235)	0.914*** (0.377)
Observations	5,728	5,728	5,728	5,728

Notes: * 0.1 ** 0.05 *** 0.01. Each observation is an admin2 level region and there are 358 admin2 regions in China. 43 regions are treated by any subsidy. Time: 2004-2020. Each column is one sdid regression. Without controls. The coefficient is the ATT which averages the staggered treatment effect. All regressions without controls. 25.6% of the utility + invention patents are classified as LBD patents.

Back

Characterising the control group

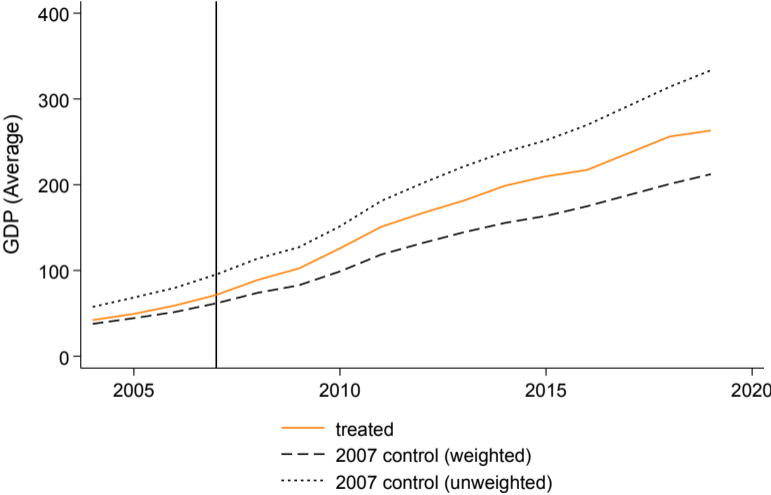

Potential pretrend

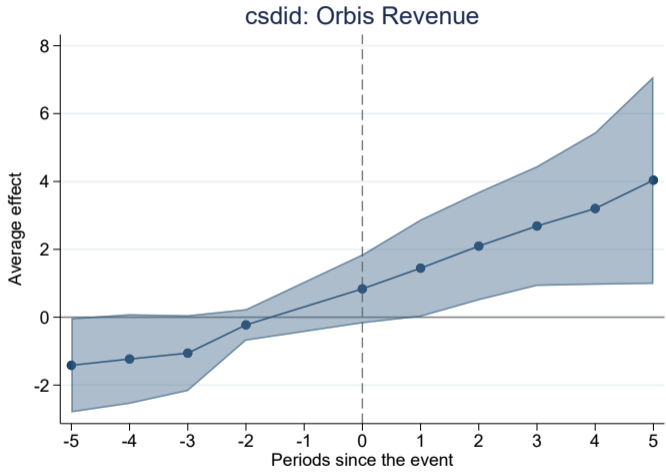

Back